

No.201-3

basic audio

by **NORMAN H. CROWHURST**

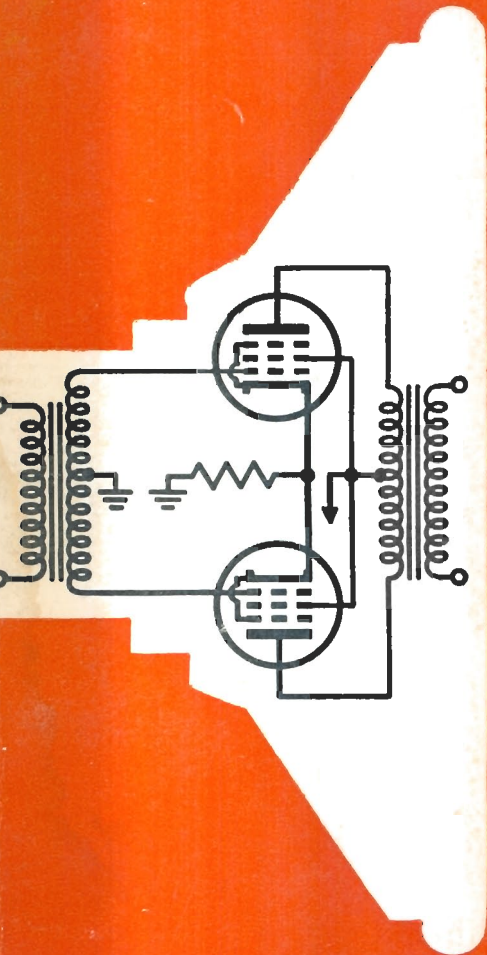

VOL. 3

FEEDBACK FUNDAMENTALS

FEEDBACK APPLICATIONS

POWER SUPPLIES

SHIELDING

AUDIO TRANSMISSION LINES

AUDIO OSCILLATORS

RECORDING

ELECTROACOUSTICS

STEREOPHONIC SOUND

a RIDER publication

Frank D. Sop

basic audio

by NORMAN H. CROWHURST

VOL. 3



JOHN F. RIDER PUBLISHER, INC.
116 West 14th Street • New York 11, N. Y.

Copyright August 1959 by John F. Rider Publisher, Inc.

All rights reserved. This book or any parts thereof may not be reproduced in any form or in any language without permission of the publisher.

Library of Congress Catalog Card Number 58-13425

Printed in the United States of America

PREFACE

Audio is like Topsy: it wasn't born, it just grew. Whatever Topsy may have been like, Audio has grown like a gawky child—not always in proportion! Originally associated with radio and later with high fidelity, audio now finds application in many other places—to name a few: computers, automation, ballistics and guidance for missiles, sonar detection for navigation, ultra- and infra-sonics for medicine, both diagnostic and therapeutic, as well as geophysical and other work. In fact Audio is now one of the largest and most basic divisions of electronics.

Courses in audio were nonexistent not too many years ago. Since then, textbooks and courses have appeared. But their approach follows the principle of many professors: "I learned it the hard way—you'll have to!" It's like learning watchmaking from a bridge-building man.

My wide experience in various aspects of audio has shown the need for a better way. In industry, in academic education, and particularly in working with graduates from college, this need is evident. My extensive technical writing for magazines and consultant work in the industry have also shown me audio's educational needs.

Many competent "practical men" find themselves hindered by lack of academic background in the subject. They can do their job in their own established "groove." But they do not have—and find it impossible to acquire—the background to enable them to expand outside this groove. These people need help in closing the gap between "theory" and "practice."

Engineers are conversant with the accepted "technical language," but they read the literature with only an "intuitive comprehension" (or should it be apprehension?). Their education dragged them past many "awkward spots" about which they have never felt really "comfortable." Like the King of Siam in "The King and I," they find many facts of which they wish they were more certain they are sure.

Very important are the new students, technicians, and audiophiles. They will need a basic education in audio to enable them to add their contribution to progress (and to earn themselves a living!). Why make it difficult? They'll do much better if they can get a good start.

All-in-all, it is time that certain roundabout approaches to this key subject were eliminated. We need a direct, meaningful way to take the place of the difficult detours. Then each of our three groups can not only "learn audio," but also understand it! This three-volume book results from the author's extensive education research. The finished arrangement achieves a completely new directness.

Let me give just one example: how many understand the behavior of a coupling capacitor, particularly its contribution to amplifier transient performance, and what sometimes happens to feedback? This has always been based on the concept of capacitive reactance, which does not adequately *explain* all the effects. We have adopted a practical "what happens?" approach.

As a result, someone who learned this the old way may miss the familiar landmark of the reactance concept—when he expects it; a closer examination will reveal the reason for postponing it: the whole presentation has been arranged to avoid the "dead spots" left by the traditional approach.

Inevitably such a change of approach will mean a change of stress. I make no apology for this. I know from practice that it is far more successful in getting Basic Audio "across."

It would be impossible to acknowledge the very many who have, knowingly or unknowingly, contributed to my experience, making this book possible. But I would like to express my thanks to the John F. Rider staff for their cooperation in "packaging" it in a form that interprets my intentions so well.

NORMAN H. CROWHURST

New York, N.Y.
August 1959

CONTENTS

VOL. III — BASIC AUDIO

Feedback Fundamentals	1
Questions and Problems	14
Feedback	15
Feedback Applications	25
Controls	31
Questions and Problems	39
Plate Voltage Supply	40
Grid Bias Supply	51
Screen Bias Supply	56
Filament or Heater Supply	59
Transformerless Power Supply	61
Questions and Problems	63
Shielding	64
Audio Transmission Lines	71
Transient Effects	75
The Audio Amplifier	78
Audio Oscillators	79
Questions and Problems	83
Recording	84
Electro-Acoustics	94
Audio and Hearing	98
Questions and Problems	106
Index	107

FEEDBACK FUNDAMENTALS

Feedback and Distortion

FEEDBACK -- A MEANS OF REDUCING DISTORTION

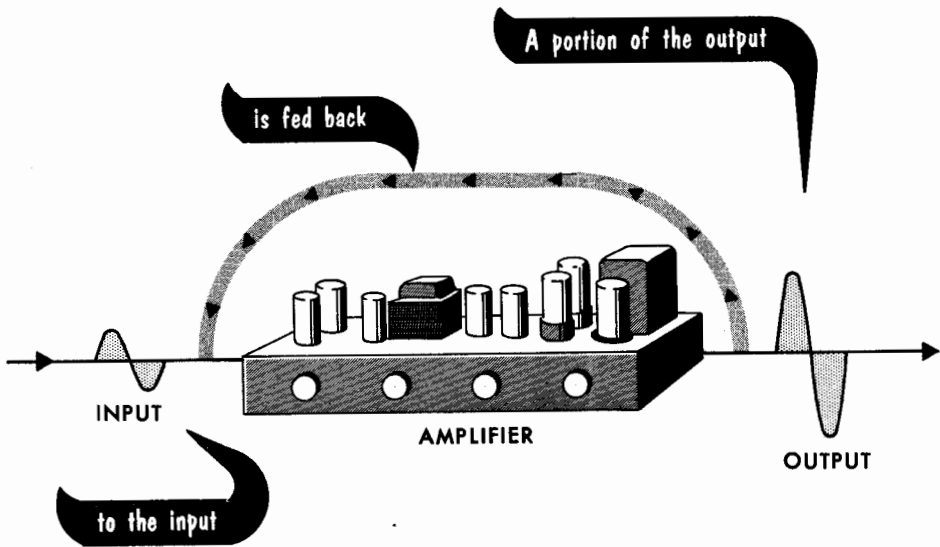

Distortion in the fed-back signal acts to reduce distortion in the output

As the development of audio amplifiers produced better and better performance, the struggle to reduce distortion became steadily greater. A point of diminishing returns was reached, beyond which it did not seem possible to go. Then came the idea of *feedback*.

Tube development has made it easily possible to get more *gain* from an amplifier. What proved difficult was getting the output to be a more exact replica of the input. Feedback uses some of the additional gain, which can easily be obtained, to achieve this objective. A portion of the output is fed back or returned to the input. The difference between the input and output waveforms, which represents the distortion component, acts to reduce the amount of the distortion.

FEEDBACK FUNDAMENTALS

Feedback and Distortion (contd.)

Suppose that an amplifier originally gives an output of 10 volts for an input of 10 millivolts and that the 10 volts contain 5% distortion. This will be 0.5 volt of some frequency (the distortion) that was not included in the 10-millivolt input.

It is comparatively easy, by using an extra tube, to increase the gain of an amplifier so that an input of only 1 millivolt will produce the 10-volt output. Bearing this in mind, if we take a 9-millivolt sample of the output and *subtract* this from the original input of 10 millivolts, we shall have the required 1-millivolt input. This input consists of 10 millivolts original audio *minus* 9 millivolts fed back from the output, which is introduced into the signal by the amplifier. If there is 5%, or 0.5-volt distortion in the 10-volt output, the 9 millivolts fed back to the input will include 0.45-millivolt distortion.

The original audio *almost* cancels itself by the feedback — for the 1 millivolt actually fed into the amplifier, 9 millivolts are fed back to offset the 10 millivolts of audio fed into the complete arrangement. The distortion component, however, which originally was 0.5 volt in the output, has no original input to “offset,” hence the whole distortion component fed back from the output will get amplified again and thus come out as 9/10 of its original size in the opposite direction. Thus, the ultimate amount of distortion left will be 1/10 of the original 5%, 0.5%, or .05 volt.

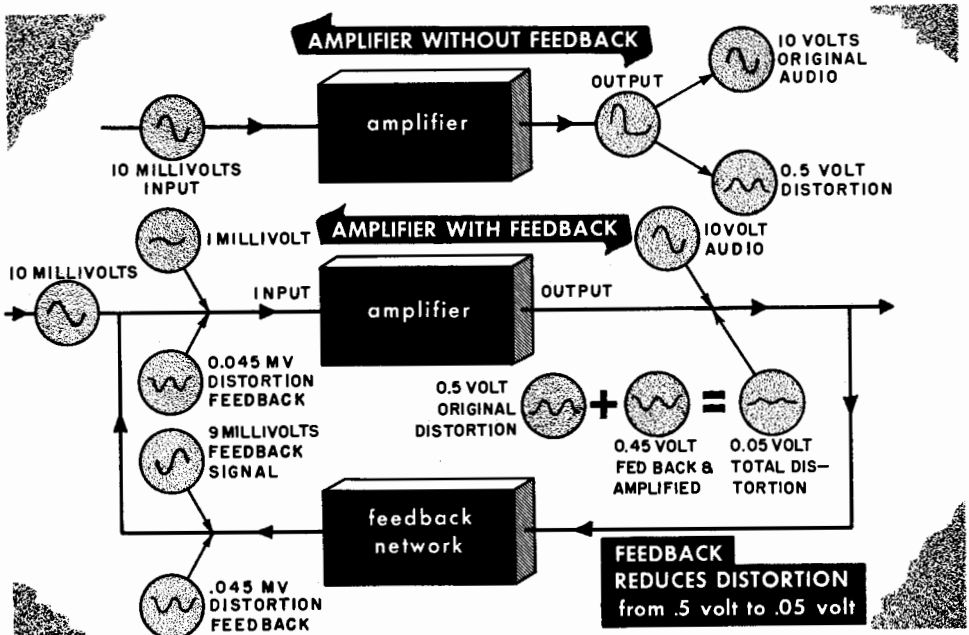

FEEDBACK FUNDAMENTALS

Negative Feedback

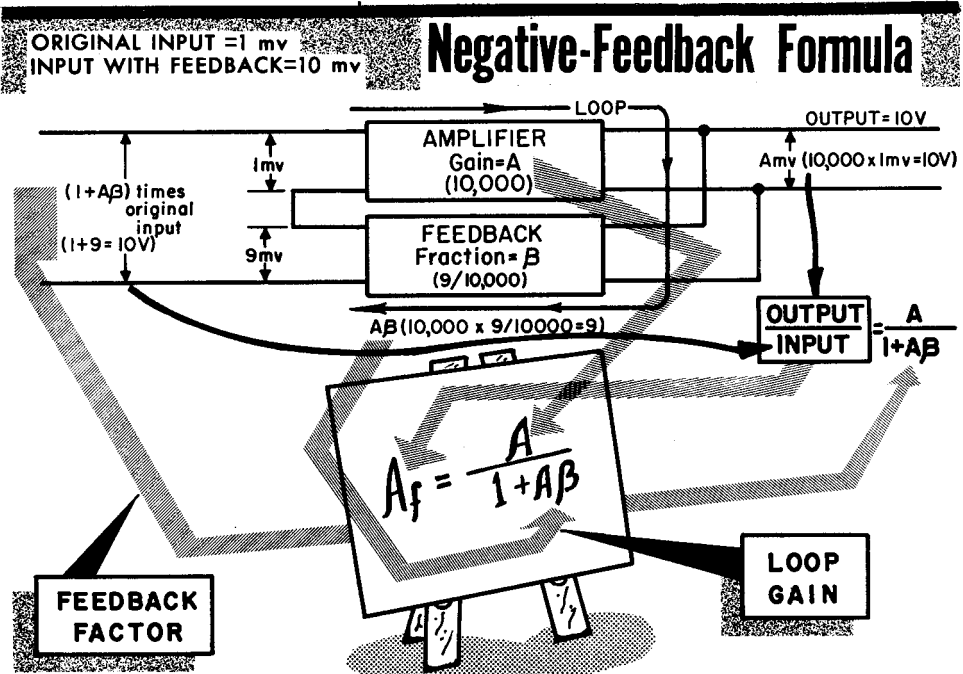

Negative-Feedback Formula for Distortion

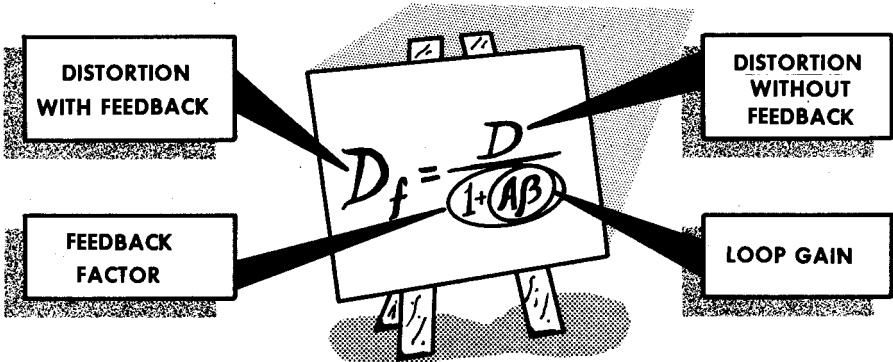

This is the formula for *negative* feedback, because the sample fed back from the output is in the *opposite* direction or phase from the input. In addition, feedback can also be *positive*.

FEEDBACK FUNDAMENTALS

Positive Feedback

Using the original amplifier as a starting point, with a gain of 1000 (a 10-millivolt input produces 10-volt output), we could take the sample from the output the other way round, so it *provided*, say, 4/5 of the required input. This would mean 8 millivolts would be taken from the 10-volt output and fed back to the input, hence the actual input only needs to provide the *remaining* 1/5, or 2 millivolts. The addition of positive feedback thus *increases* the gain of the amplifier, instead of reducing it as with negative feedback. When positive feedback is used, the formula for gain with feedback is rewritten as $A_f = A/(1 - A\beta)$.

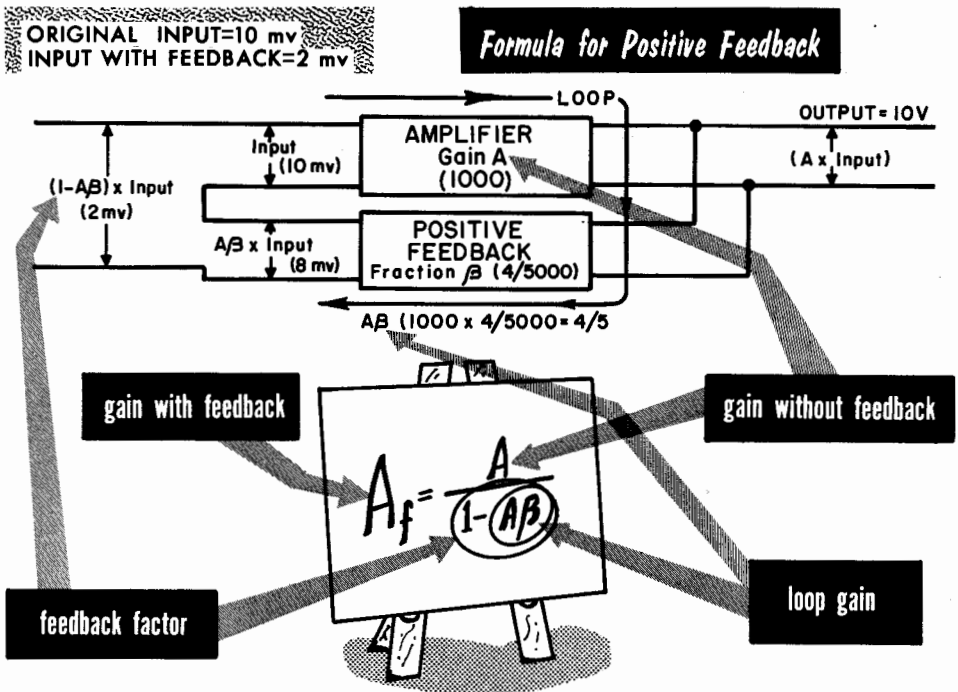

A represents the gain of the amplifier and β (a Greek letter called "beta"), represents the *fraction* fed back. The quantity $A \times \beta$ or $A\beta$ is called the *loop gain*. It is the *net* gain of the combined arrangement, measured from the input to the amplifier, through to the output, and back through the feedback to the input again. The denominator of the fraction ($1 + A\beta$ or $1 - A\beta$) is called the *feedback factor*, or sometimes just *feedback*. It represents the amount by which the gain is divided by connecting the feedback.

For positive feedback, the feedback factor is $(1 - A\beta)$. Thus, it is always a fraction. Hence, the gain will be *greater* than it was originally, because any number divided by a fraction becomes greater than the original number.

FEEDBACK FUNDAMENTALS

Decibel Calculations

		NUMBER OR RATIO	DECIBELS
Amplifier gain (without feedback)	A	10,000	80
Feedback fraction	β	$\frac{9}{10,000}$	-61
Loop gain	$A\beta$	9	19
Feedback factor	$(1+A\beta)$	10	20
Amplifier gain with Feedback	$\frac{A}{(1+A\beta)}$	1,000	60

$80 - 61 = 19$

$\frac{9}{10,000} = .0009$

$10,000 \times \frac{9}{10,000} = 9$

$9 + 1 = 10$

$\frac{10,000}{10} = 1,000$

$80 - 20 = 60$

TYPICAL db TABLE

ratio	db	ratio	db
.0009	-61	1000	60
9	19	10,000	80
10	20		

$$\text{Decibels} = 20 \log_{10} \frac{E_2}{E_1} = 20 \log_{10} A$$

Amplifier gain figures are often given in *decibels*, and we may encounter feedback referred to in decibels as well. It is, however, always more convenient to make the calculation in *ratios* and convert the *result* to decibels. This avoids confusion.

In the negative feedback example that we discussed, the gain of the amplifier without feedback was 10,000 or 80 db. The feedback fraction was 9/10,000, or approximately -61 db. Hence, the loop gain $A\beta$ is $80 - 61 = 19$ db. This corresponds to the loop gain ratio of 9. The feedback factor is $1 + 9$ or 10, which is 20 db. So in this case, the loop gain is 19 db and the feedback is 20 db. For negative feedback, the bigger the loop gain, the nearer the two figures come to coinciding. If the loop gain were 99 (39.9 db), the feedback would be 100 (40 db).

FEEDBACK FUNDAMENTALS

Voltage Feedback

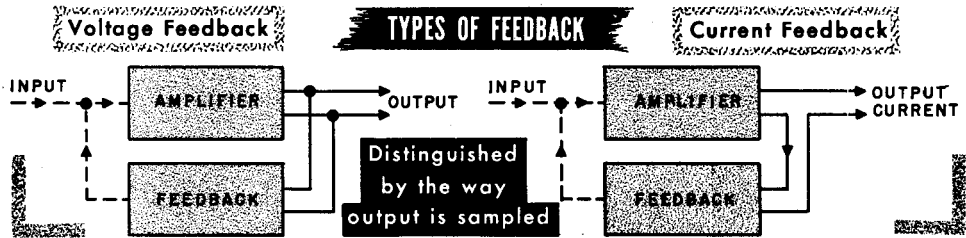

There are several ways in which feedback may be distinguished. For example, either the output *voltage* or the output *current* can be used as a basis for the output "sampling." The chief difference as far as the operation of the amplifier is concerned is in the effect on the amplifier's effective output impedance.

Let us work out a typical example, using voltage feedback. Suppose that an amplifier has to work with a 15-ohm resistance as its output load. It has an internal resistance due to the plate resistance of the output tubes of 5 ohms. Without the output load connected, a 10-millivolt input produces a 10-volt output. Without feedback, a 2-millivolt input would produce the 10-volt output. This means the gain of the amplifier, A , is 5000, or 74 db. The feedback, β , is 8 millivolts fed back for 10 volts at the output, $8/10,000$ or $4/5000$. The loop gain, $A\beta$, thus is $5000 \times 4/5000$ or 4. The feedback ($1 + A\beta$) is $1 + 4$ or 5, which corresponds to 14 db. This means the gain and distortion will be divided by 5. Connecting the 15-ohm load causes the same 2 millivolts at the input of the actual amplifier to produce (10 volts \times 15 ohms/20 ohms) 7.5 volts output.

With No Load Connected

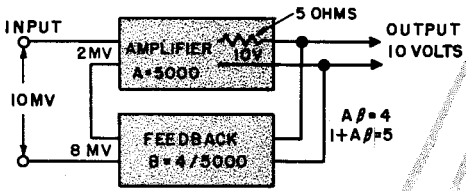

With Load Connected

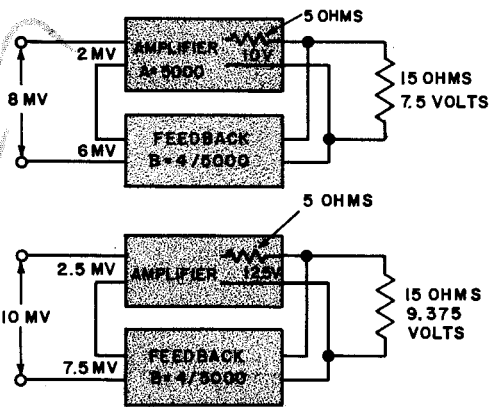

HOW VOLTAGE FEEDBACK WORKS

START WITH 2MV HERE
CHANGE 8MV BACK TO ORIGINAL 10V, MULTIPLY ALL VOLTAGES BY RATIO $10/8$

FEEDBACK FUNDAMENTALS

Voltage Feedback (contd.)

Because β is .0008, a 7.5-volt output will produce 6 millivolts of feedback. The total input required to give a 7.5-volt output with the load as well as the feedback connected is (2 + 6) or 8 millivolts. By simple proportion we can deduce the output with a 10-millivolt input. It will be $(7.5 \times 10/8)$ or 9.375 volts. Thus the *effective* drop in the internal resistance (because feedback changes the *actual* input) is from 10 volts (without the load connected) to 9.375 volts (with the load connected), a difference of 0.625 volt. As it takes a load of 15 ohms to do this, the internal resistance must be $0.625/9.375 \times 15$ ohms, or 1 ohm. The connecting of feedback, which has reduced the gain by a ratio of 5, has also reduced the effective internal resistance of the output by the same ratio. Without feedback, the internal resistance was 5 ohms; with feedback it is 1 ohm.

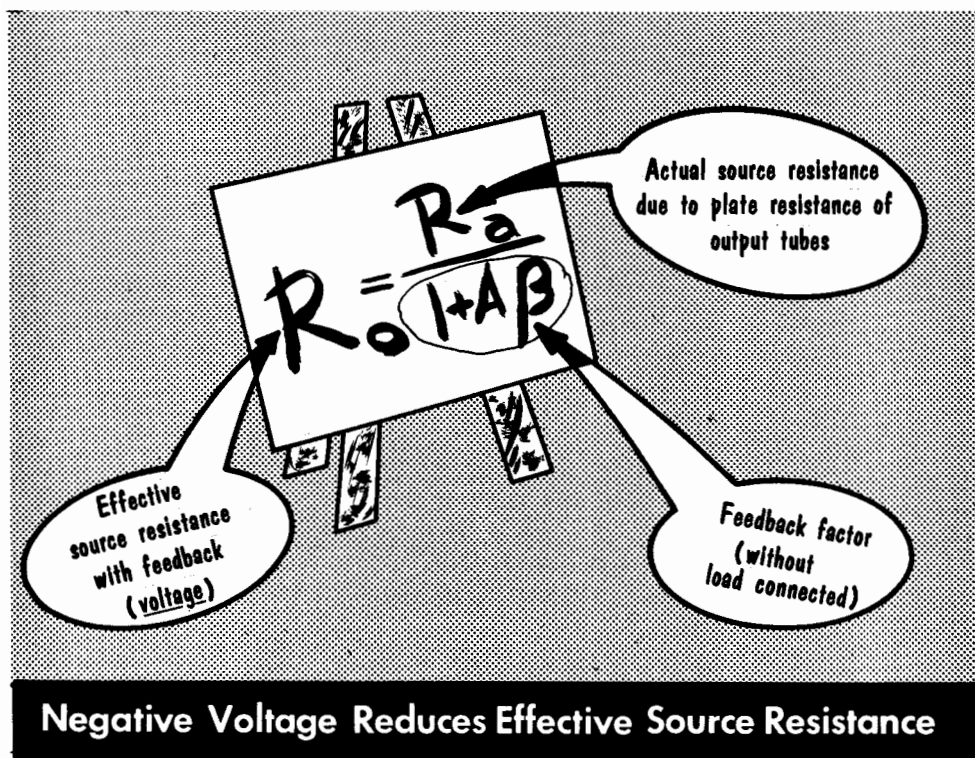

We could use the formula instead of the numbers and come out with the same answer — that the internal resistance with voltage feedback is divided by the same factor that the gain is reduced by. An important point to notice (not stated in many textbooks on the subject) is that we must use the gain *without the load connected* in this formula.

FEEDBACK FUNDAMENTALS

Current Feedback

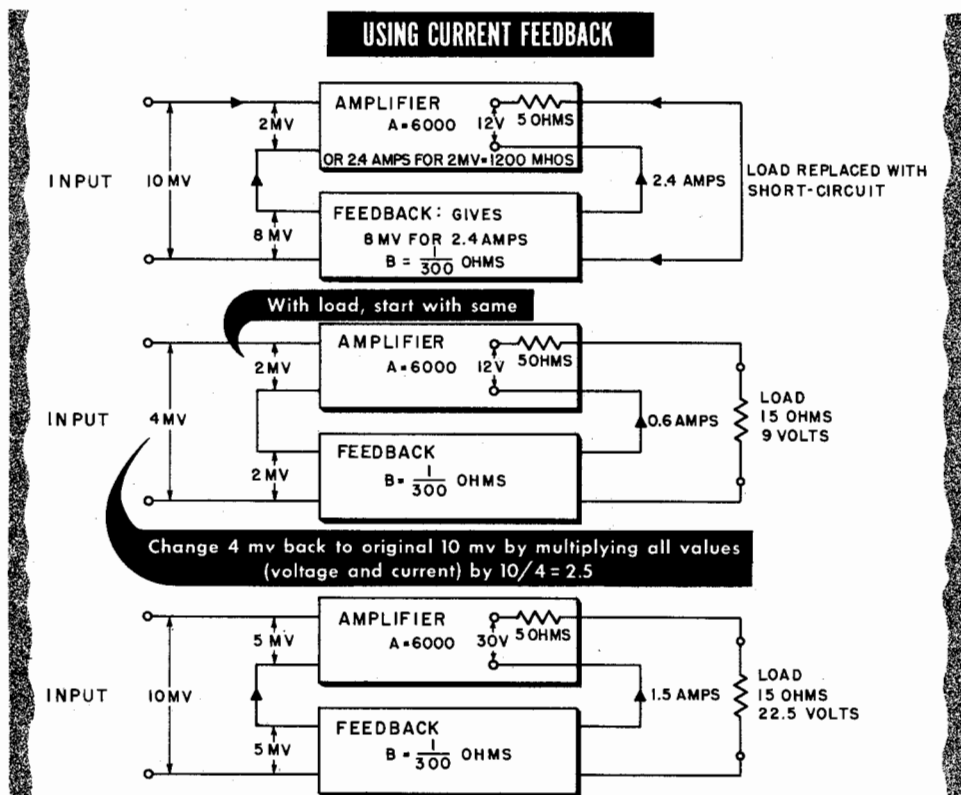

The other way in which the output can be sampled is called *current feedback*. Assume that we have an amplifier that without any load connected gives 12 volts output for an input of 2 millivolts. It has an internal resistance of 5 ohms. When the output is short-circuited, the internal resistance will be the only thing to limit the current— $12/5 = 2.4$ amperes. Assume that this 2.4-ampere output produces 8 millivolts of feedback and that the current feedback is always in this ratio.

This means the amplifier, complete with feedback, requires 10 millivolts input to produce a 2.4-ampere output on short-circuit. Now assume that the 15-ohm load is connected to the amplifier, still with 2 millivolts at the input. The original 12 volts at the output will produce a current of $(12/20)$ or 0.6 ampere (which produces 9 volts across the 15-ohm load). Because the 2.4 amperes cause 8 millivolts of feedback, the 0.6 ampere will produce $8 \times 0.6/2.4$ or 2 millivolts feedback. Thus the input required for this condition will be a total of $(2 + 2)$ or 4 millivolts. Assuming that we still apply the original 10 millivolts of input, the output current will then be $(0.6 \times 10/4)$ or 1.5 amperes.

FEEDBACK FUNDAMENTALS

Current Feedback (contd.)

Now we have a basis for comparison. With the output short-circuited, the feedback amplifier with a 10-millivolt input gives a 2.4-ampere output. With the load of 15 ohms on the output, the same 10 millivolts input produces a 1.5-ampere output.

-- No load results in no feedback --

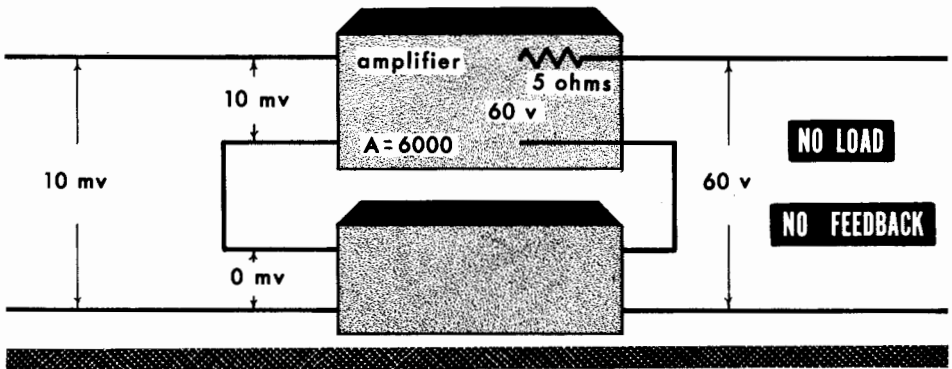

CURRENT FEEDBACK RAISES SOURCE RESISTANCE

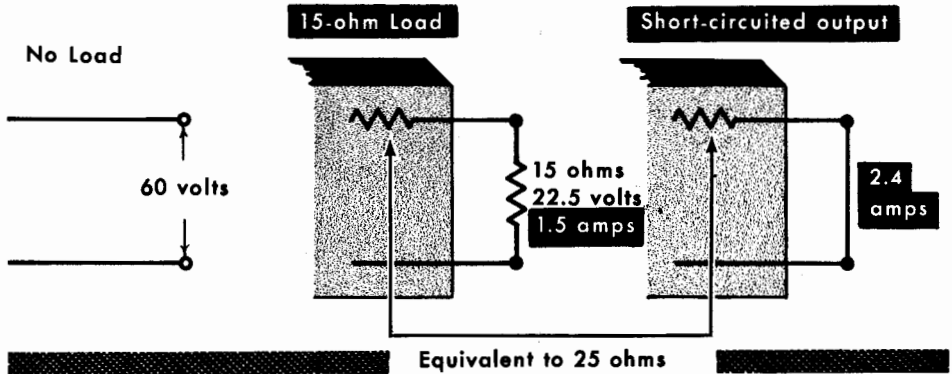

We can take the matter one stage further and consider the output with no load at all. If there is no current, there will be no feedback and a 10-millivolt input will produce $(10/2 \times 12)$ or a 60-volt output. With the current feedback applied and a 10-millivolt input, the effective open-circuit output voltage is 60 volts, whereas the short-circuited current is 2.4 amps. This means the *effective* internal resistance is $60/2.4$ or 25 ohms.

FEEDBACK FUNDAMENTALS

Current Feedback (contd.)

This checks with the loaded condition as well. When the 15-ohm load is connected, the total effective resistance is (25 + 15) or 40 ohms. This resistance connected across an effective 60-volt source will allow a current of 1.5 amperes, as calculated earlier. The current feedback has multiplied the effective source resistance by 5. (The actual value is 5 ohms and the effective value is 25 ohms.) The reduction in gain caused by the feedback is 5, *only when the amplifier operates short-circuited.*

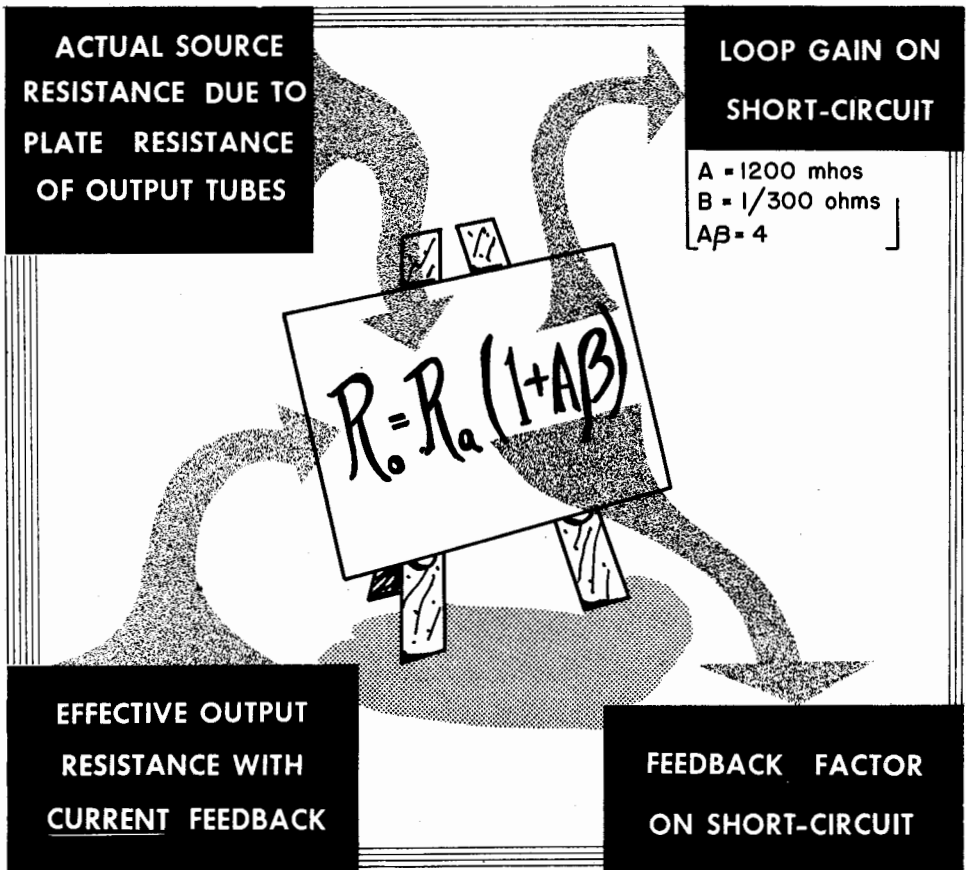

At normal loaded condition, the reduction in gain due to feedback is 2. (Without feedback, 2 millivolts produces the same output as 4 millivolts does with feedback.) Disconnecting the load entirely results in no feedback. Thus, for *current* feedback, the *effective* output source resistance is the actual source resistance multiplied by the feedback factor when the amplifier output is short-circuited.

FEEDBACK FUNDAMENTALS

Series Injection

Feedback Circuits can be classified according to the Method of Feedback Injection

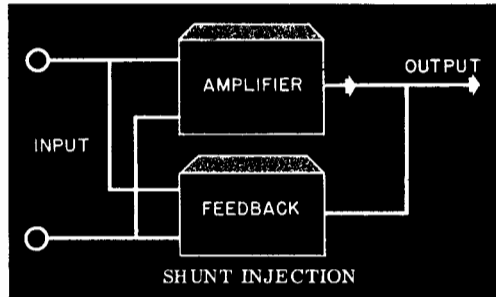
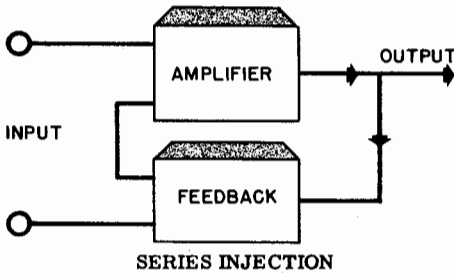

Another way of distinguishing between different types of feedback is in the way in which the feedback is injected at the input end of the amplifier. It can be injected either in series or in parallel (shunt) with the input resistance of the amplifier itself. The effective *input* resistance of the amplifier is affected by the method of injection. When feedback is injected in series with the input to the amplifier (as we have assumed it to be thus far because this system is the simplest to follow), we assume that only voltages are being considered. There are always small currents as well.

When the 10-millivolt input is applied, the input resistance to the amplifier will draw a current, depending upon its value. If the input resistance were 100,000 ohms, 10 millivolts applied across it would produce a current of 0.1 microampere. Due to the feedback of 9 millivolts, however, the input resistance of 100,000 ohms has only 1 millivolt across it, which means it will draw only .01 microampere. Thus, from the viewpoint of the 10-millivolt total input, the resistance appears to be not 100,000 ohms, but 1,000,000 ohms, or 1 megohm. We may conclude that series injection causes the input resistance to be multiplied by the feedback factor — in this case, 10.

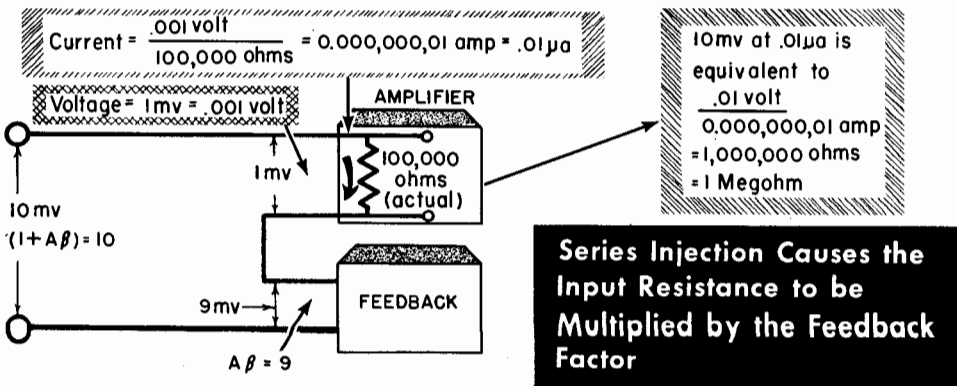

FEEDBACK FUNDAMENTALS

Shunt Injection

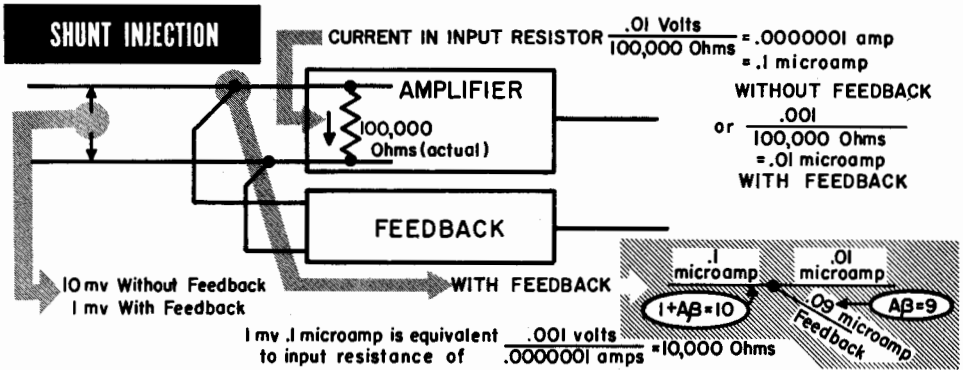

In shunt injection we must also consider the input current as well as the input voltage. Again assuming an input resistance of 100,000 ohms and an input current of 0.1 microampere, this would produce an input of 10 millivolts. However, the feedback current will provide 9/10 of the total input current in this case, or .09 microampere, leaving a current through the input resistance of only .01 microampere. This current would produce a voltage drop of only 1 millivolt.

Thus, although the input *current* is still 0.1 microampere, the input *voltage* is only 1 millivolt instead of the 10 millivolts it would be in the absence of feedback. The *effective* resistance now is 10,000 ohms instead of 100,000 ohms, and shunt injection has *divided* the input resistance by the feedback factor.

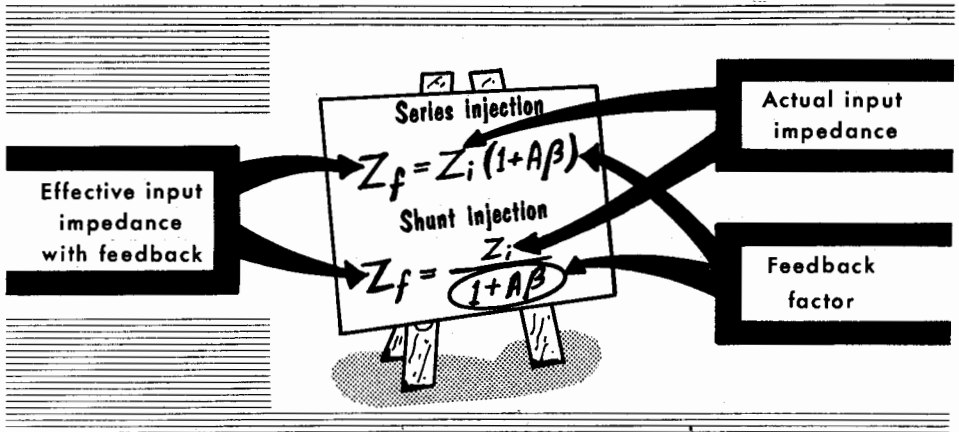

We can now analyze some practical feedback circuits to see how they classify under these different distinctions.

FEEDBACK FUNDAMENTALS

Feedback Amplifier Arrangements

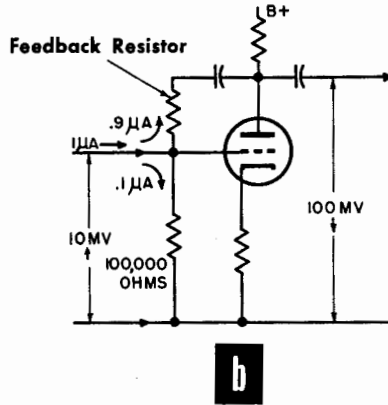
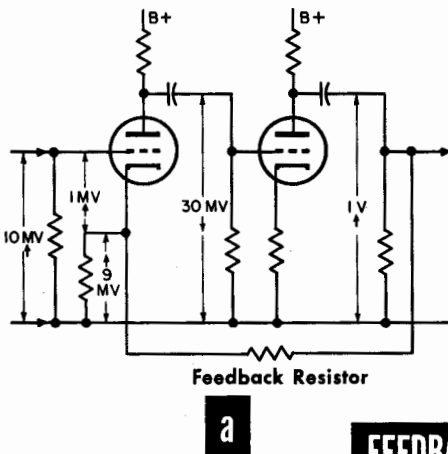

FEEDBACK CIRCUITS

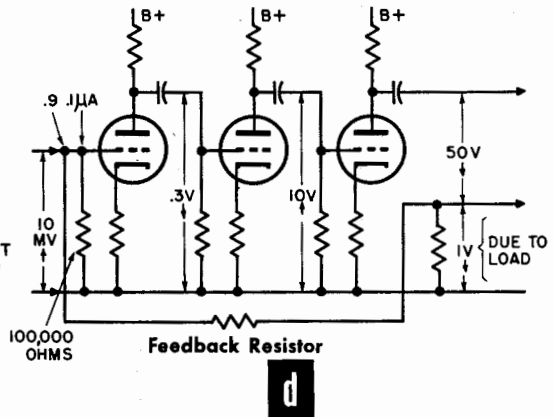
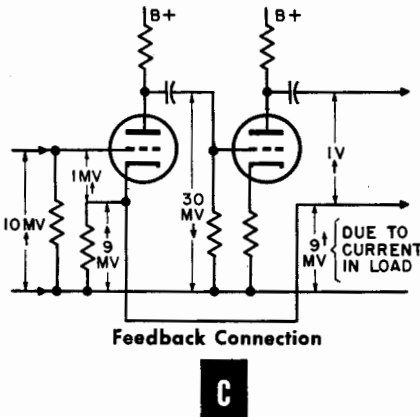

CIRCUIT		a	b	c	d
Kind of feedback	Current or voltage	VOLTAGE	VOLTAGE	CURRENT	CURRENT
	Series or shunt	SERIES	SHUNT	SERIES	SHUNT
Effect on gain		$\div (1 + A\beta)$			
Effect on distortion		$\div (1 + A\beta)$			
Effect on output source impedance		$\div (1 + A\beta)$	$\div (1 + A\beta)$	$\times (1 + A\beta)$	$\times (1 + A\beta)$
Effect on input impedance		$\times (1 + A\beta)$ CONNECTED GRID-CATHODE	$\div (1 + A\beta)$	$\times (1 + A\beta)$ CONNECTED GRID-CATHODE	$\div (1 + A\beta)$

QUESTIONS AND PROBLEMS

1. What simple facts about amplifiers led to the use of negative feedback to reduce distortion? If feedback reduces the gain by a ratio of 5:1, by how much should distortion be reduced?
2. What is the basic difference between positive and negative feedback? Show, with a sketch, the difference between loop gain and feedback factor.
3. What is the maximum loop gain that can be used with positive feedback without causing oscillation?
4. Explain the effect of (a) voltage feedback and (b) current feedback on amplifier output impedance. State clearly any condition that should be specified concerning the amount of feedback in figuring this effect.
5. Explain the effect of feedback, using (a) series injection and (b) shunt injection on input impedance in an amplifier.
6. The loop gain in an amplifier using negative feedback is 12 db. What is the feedback factor, in db?
7. Without feedback, an amplifier has an output source resistance that is 3 times its nominal load resistance. What will be the value when voltage feedback is used that reduces gain by 26 db without the load connected? Or with current feedback that reduces gain by 6 db with the output short-circuited?
8. With the output load connected, a pentode output amplifier shows a reduction in gain of 20 db when voltage feedback is connected. What is the approximate source resistance (as a multiple or fraction of load impedance) with feedback connected? How could you evaluate the source resistance without feedback connected?
9. Without feedback, an amplifier shows 8% distortion unloaded, and 5% loaded, at maximum rated output voltage. Changing the output loading requires an input change of 8 db to maintain the voltage. Feedback is connected that reduces gain by 20 db in the loaded condition. Calculate: (a) the source resistance (as multiple or fraction of nominal load) without feedback; (b) the feedback, using the same circuit unloaded; (c) the source resistance with feedback; (d) distortion with feedback, unloaded; (e) distortion with feedback, loaded.
10. An amplifier uses overall feedback, voltage derived at the output, and series injected at the input. Without the load connected, removal of the feedback connection increases gain by 46 db. With it connected, the reduction is 26 db. An input resistor of 100,000 ohms is across the basic amplifier input (inside the feedback loop). Calculate: (a) the source resistance without feedback; (b) the source resistance with feedback; (c) the input impedance with feedback, the output being unloaded; and (d) the input impedance with feedback, the output being loaded.

FEEDBACK

Phase Shift Due to Feedback

Thus far we have talked about feedback as being either *positive* or *negative*, as if the fed-back voltage (or current) *either* adds to *or* subtracts from the original input. This has helped us to lay down the simple rules of feedback. Practical circuits, however, do not behave quite as simply as this. At some frequencies, the fed-back audio is neither precisely in phase nor precisely out of phase with the original input, but somewhere in between. The resulting voltage fed to the amplifier input is what is called the *vector difference* between the input and the fed-back audio. We can see by examining the waveforms that their relationship is very much like that between voltage and current in a series circuit containing resistance and capacitive reactance.

All amplifiers possess some reactance, such as coupling capacitors, which affect the low-frequency response, and stray capacitances, which affect the high-frequency response. The output voltage gets out of phase with the ideal arrangement of negative or positive feedback, as the case may be, at these frequencies.

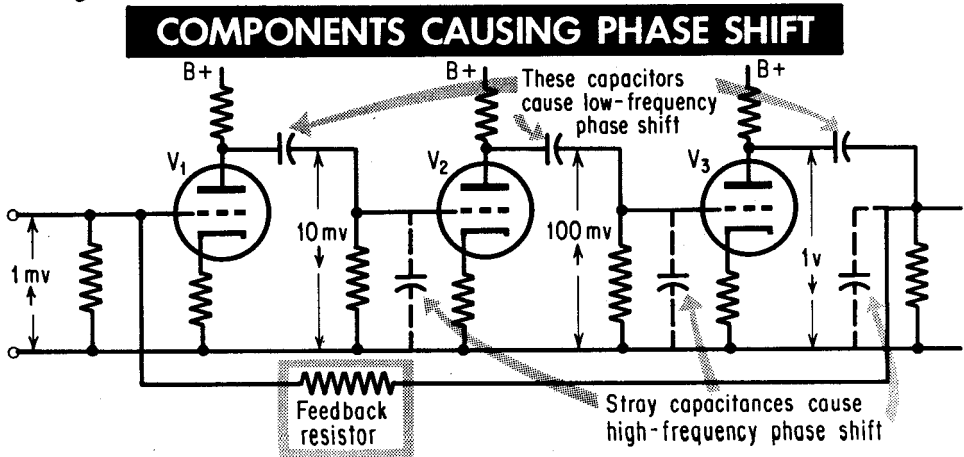
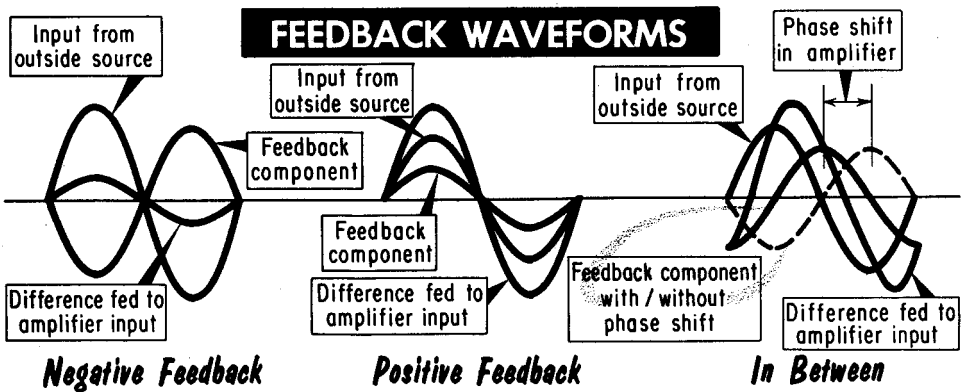

FEEDBACK

Phase Shift Due to Feedback (contd.)

PHASE RESPONSE OF THE AMPLIFIER

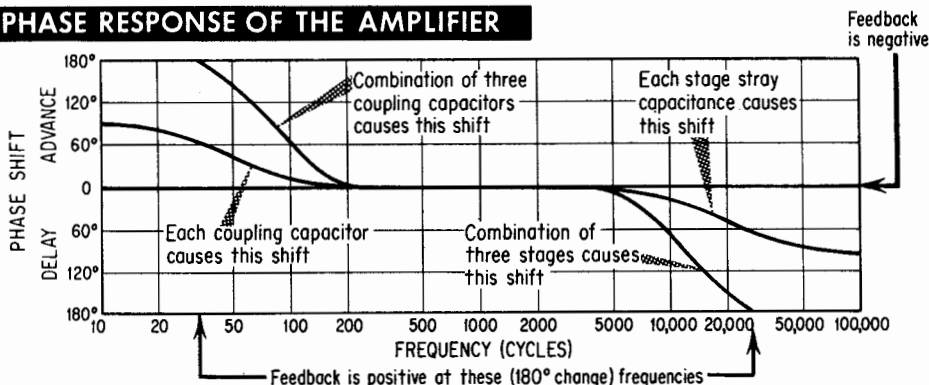

Take the effect of the coupling capacitors on the low-frequency response. If each of these capacitors produces a phase difference of 60° at the same frequency, the total phase shift adds up to 180° . This amounts to phase reversal. If the feedback starts out being negative at this particular frequency, it will convert into positive feedback.

The dangerous thing now is that, with positive feedback, the amplifier will oscillate because the output voltage will equal the input voltage; consequently, no *external* input voltage is needed — the amplifier will continue to amplify its own output at this particular frequency.

This critical point is a loop gain $A\beta = 1$. In the formula for positive feedback, the feedback factor (by which the gain is divided) is $(1 - A\beta)$. As we said before, this is always a *fraction*, so the gain is not reduced in fact, but increased. However, when $A\beta$ becomes equal to 1, then $1 - A\beta = 0$. *Anything* divided by zero is infinity. It means that the gain of the amplifier becomes infinite at this frequency, and will go on amplifying its own output indefinitely, without the need for any input.

THREE-STAGE AMPLIFIER

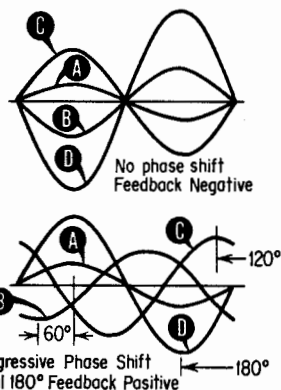
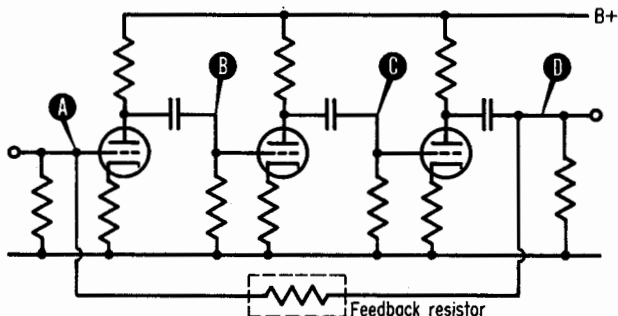

FEEDBACK

The Loop Gain — Nyquist Diagram

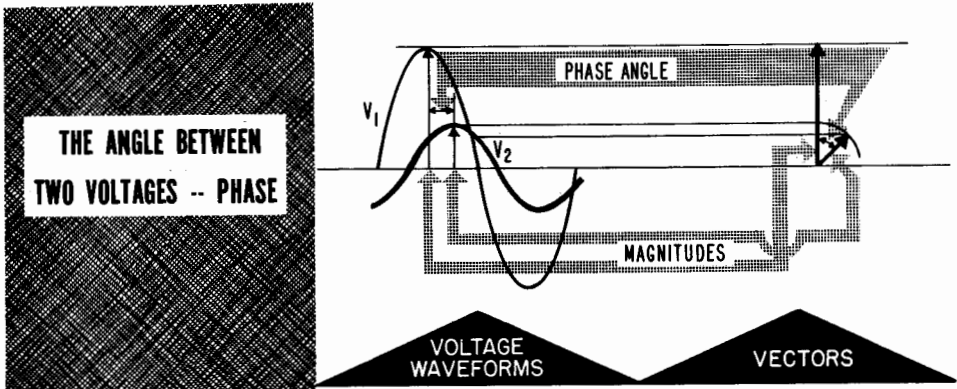

We are fortunate that this time difference between the voltage fluctuation at different points in an amplifier at various frequencies can be designated as a *phase angle*. This means that we can draw a “picture” of the voltage with what is called a *vector*. It is a line drawn at an angle to correspond with the phase angle from a starting point representing zero.

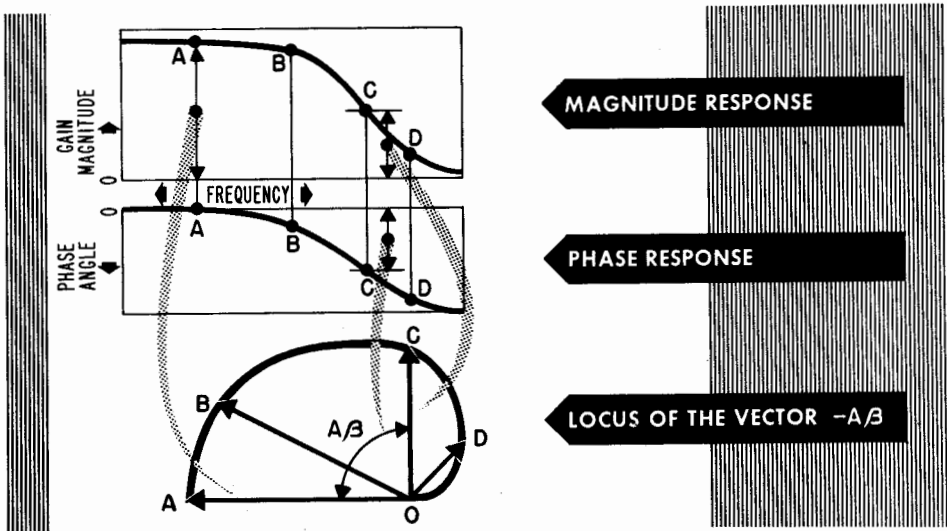

The loop gain $A\beta$ is the important thing to consider. We can draw a series of lines from a starting point called O (for Origin). Each line represents both the magnitude and the phase angle of $A\beta$ for a different frequency. Joining the outer ends of these lines produces a curve that represents all possible positions for the tip of the $A\beta$ vector and shows how $A\beta$ varies in phase and magnitude due to frequency changes. This curve is called a Nyquist diagram.

FEEDBACK

Nyquist Diagram (contd.)

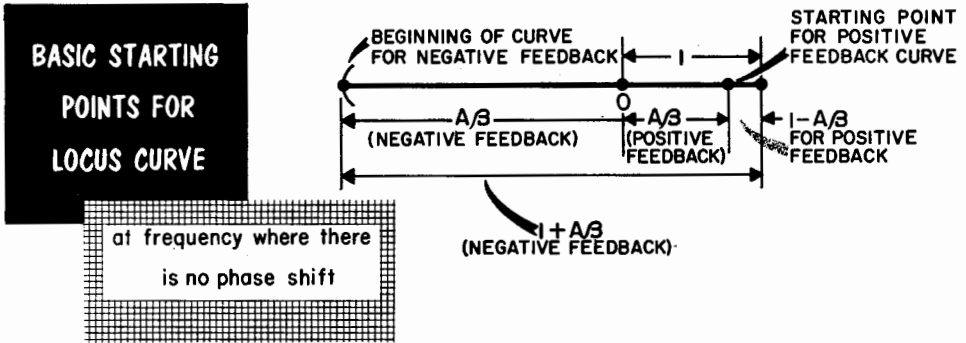

In the case of negative feedback, the feedback factor is $(1 + A\beta)$. First we draw a line in one direction from O, representing $A\beta$. Assuming that there is no phase shift, we can mark off 1 in the opposite direction from O and the total length of the line is then the feedback factor $(1 + A\beta)$. In the case of positive feedback, both $A\beta$ and the distance will be measured in the same direction from O and the distance between the end of the line representing $A\beta$ and 1 will represent the feedback factor $(1 - A\beta)$.

Either way, the feedback factor is given by the distance between the $A\beta$ locus and the point measured off 1 unit from O. The convenience of this method is that the distance between any other point on the locus and this position, measured 1 unit from O, also represents both the magnitude and phase angle of the feedback factor.

Thus the feedback factor can be called $(1 + A\beta)$; bear in mind that $A\beta$ is not just a simple number now, but that it includes a phase angle. When this phase reaches 180° , $A\beta$ has become negative instead of positive, and represents fully positive feedback.

A rigorous proof of this would involve mathematics beyond the scope of this book, and an exact explanation would call for a knowledge of complex numbers. Looking at it as a simple geometrical diagram, however, can give us a good picture of what happens without knowing all the mathematics.

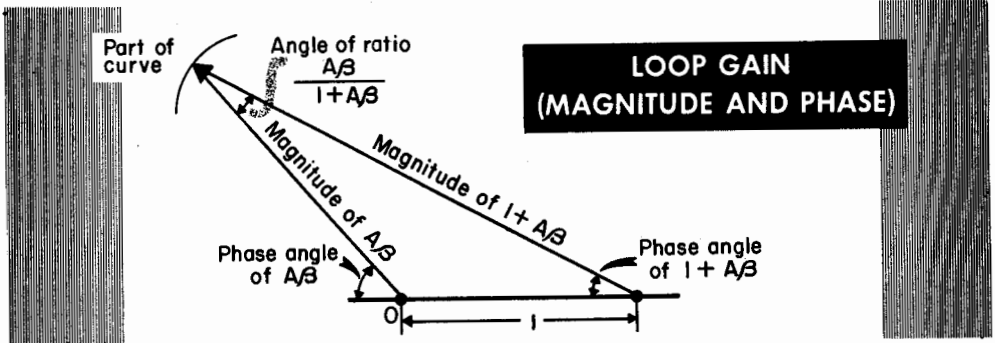

FEEDBACK

Nyquist Diagram (contd.)

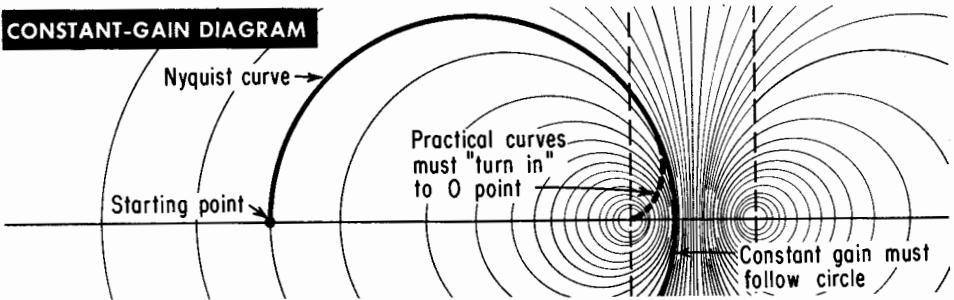

The locus vector curve itself is called a *Nyquist diagram*. If the curve representing the locus of $A\beta$ follows one of the circles which represents a constant ratio of distances from O and 1 , the gain of the amplifier with feedback would be *constant*, although there would be *phase change* in both $A\beta$ and $(1 + A\beta)$, as well as a transition from positive to negative value of $A\beta$.

This particular response is impossible with any practical amplifier. At some frequency, A must fall to zero. Usually this happens at a very low frequency and at a very high frequency, due to ultimate loss in the coupling capacitors at the low-frequency end and stray capacitance between stages at the high-frequency end. Either way, when $A\beta$ falls right down toward zero, the curve must turn in and go to the point O . None of the circles representing constant ratio goes through the point O ; all pass between the points O and 1 and out beyond them on opposite sides, one side or the other, except for the line that represents $A\beta = 1 + A\beta$ which is a straight line perpendicular between the two points. As a practical amplifier has frequency limitations and eventually loses gain completely at extreme frequencies, it cannot follow any of these constant-gain lines (circles) *all the way*.

We can use this diagram, however, to predict the overall response of the amplifier (with feedback) by the way the locus curve criss-crosses the circles drawn to represent different values of constant ratio. A complete Nyquist diagram starts from O and finishes at O , representing frequencies zero and infinity. For simplicity, we have shown half, starting from a mid-range frequency where there is no phase shift either way.

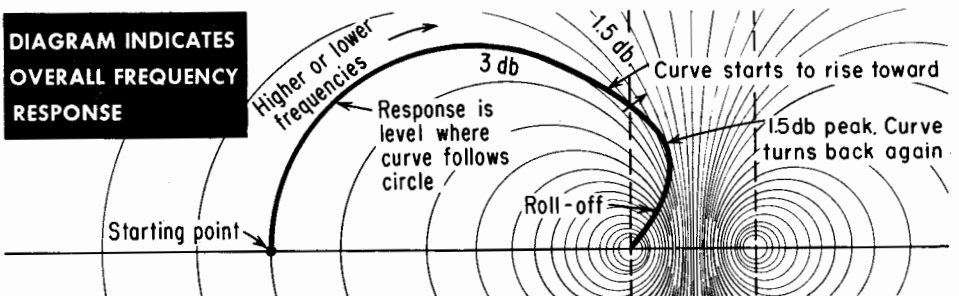

FEEDBACK

Nyquist Diagram (contd.)

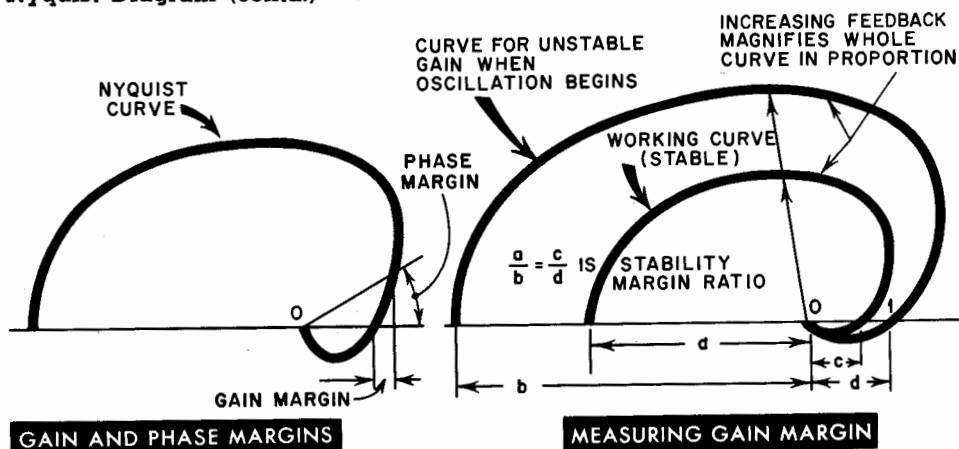

Now we can see how this same diagram shows how much margin of safety we have between the way we are working and the beginning of oscillation. Increasing the value of $A\beta$ at all frequencies uniformly multiplies up the whole size of the curve in proportion. If the curve goes round more than 180° before it turns into the source or origin point O , increasing its size eventually causes it to go through the 1 point, which means oscillation occurs. We can see how much margin there is between the point where the curve passes through the positive *direction* and the 1 *point*. As the whole curve multiplies up in proportion as the gain or feedback of the amplifier is changed, the *ratio* between this distance and 1 gives the amount by which the loop gain $A\beta$ can be increased before oscillation commences.

This ratio, expressed in db, is called the *gain margin*, because an increase by this much gain starts oscillation. This margin can actually be measured by increasing the amount of feedback until oscillation commences and then calculating the difference in loop gain between the condition at which the amplifier actually works and the amount needed to make it oscillate.

The other *criterion of stability*, as these margins are called, is the *phase margin*. This can be shown on the Nyquist diagram, but it is not at all easy to measure. Hence, the gain margin is probably of the most value in assessing the performance of an amplifier. On the diagram, the phase margin is the angle of the vector $A\beta$ at the point where the curve passes through a radius of 1 from point O , and point 1 from which distances $(1 + A\beta)$ are measured. It means that increasing the loop phase shift in the amplifier (or anywhere in A or β) by this angle would cause the amplifier to oscillate.

This statement assumes a change of the phase shift without a change of the amplification characteristic in any other way, which, in practice, is not possible. This is another reason why the phase margin is not a very practical criterion: it has no real significance, but now we have the tools.

FEEDBACK

How To Get The Right Answer

We like to use a lot of feedback but this results in conditions, if we are not careful, that cause oscillation, because $A\beta$ will be so big at the starting point that it will be difficult to have it turn in sharply enough to get "inside" the 1 point. We can look at this on the graphs of db response and phase shift caused by each coupling network. We notice that, at the 3-db point, the phase shift is just 45° . The phase shift never quite reaches 90° but the db response keeps on falling off at almost 6 db for every octave in frequency.

If we add a second arrangement with the 3-db point at the same frequency, we would double these values. There would be a 6-db loss of magnitude and a 90° phase shift. The phase shift would never quite reach 180° but the db response keeps on falling off at almost 12 db for every octave. Although this two-stage arrangement can never get as far as causing oscillation, it can cause a peak in the frequency response.

This can be shown easily by drawing this curve on top of the background of circles representing constant ratios. Changing the size of the two-stage curve alters it from a condition where it follows one of the circles and then turns in to the "back" of the point O to one where it moves outward over the circles before cutting back across them. When it gets as big as this, the response indicated is one with a peak.

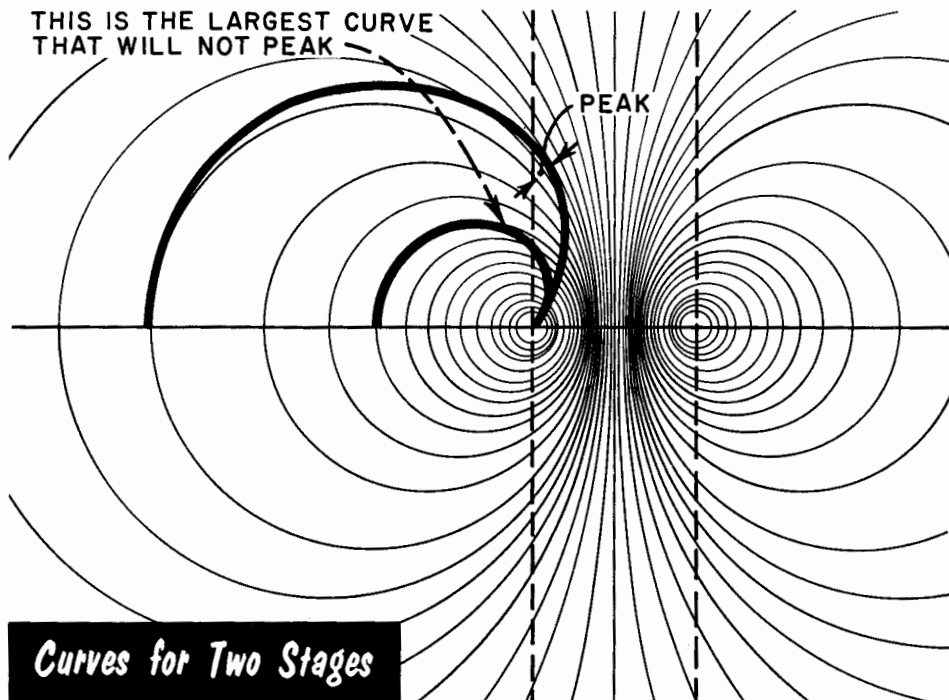

FEEDBACK

How To Get The Right Answer (contd.)

If more than two stages are used, the ultimate phase shift approaches 270° , so it must pass through 180° somewhere. The problem now is to make sure that the amplification has reduced, so $A\beta$ is less than 1, by the time the phase shift reaches 180° .

RESPONSE CURVES (HIGH-FREQUENCY END)

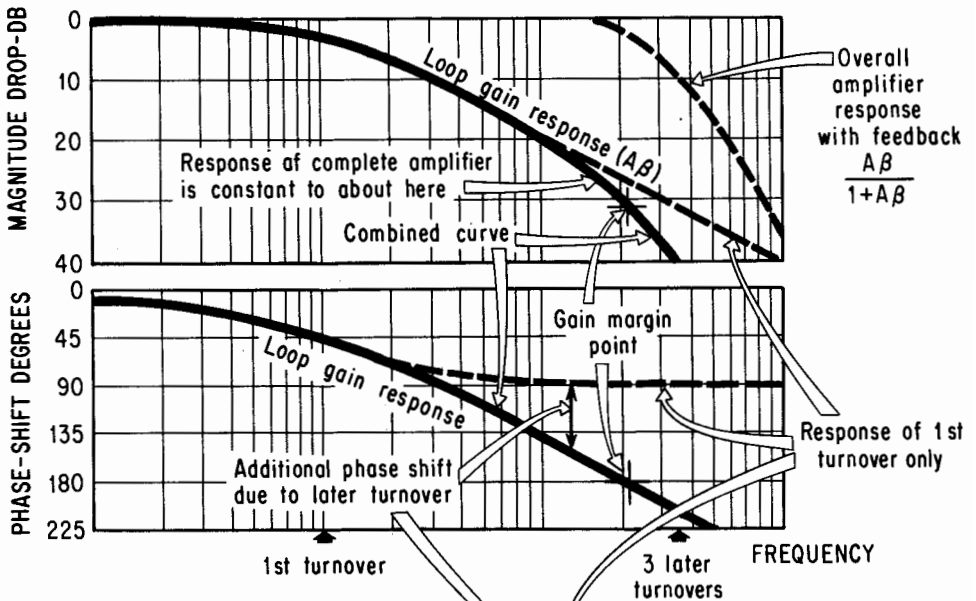

CURVES OF $A\beta$ TO SHOW HOW LARGE AMOUNTS OF FEEDBACK ARE OBTAINED WITH SEVERAL STAGES

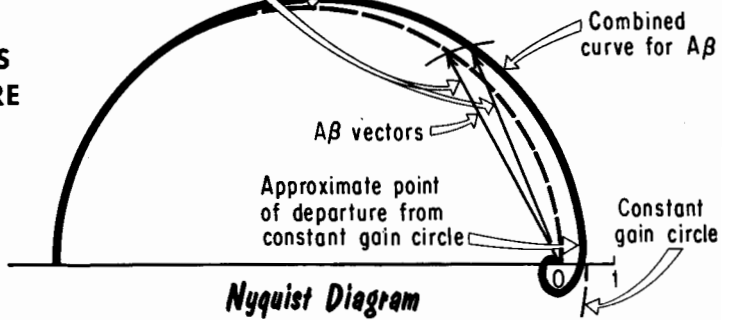

The best way of achieving this proves to be a choice in the combination of coupling capacitors values (for the low-frequency response) that causes one rolloff or 3-db point to occur at a much higher frequency than the other two (or more).

FEEDBACK

How To Get The Right Answer (contd.)

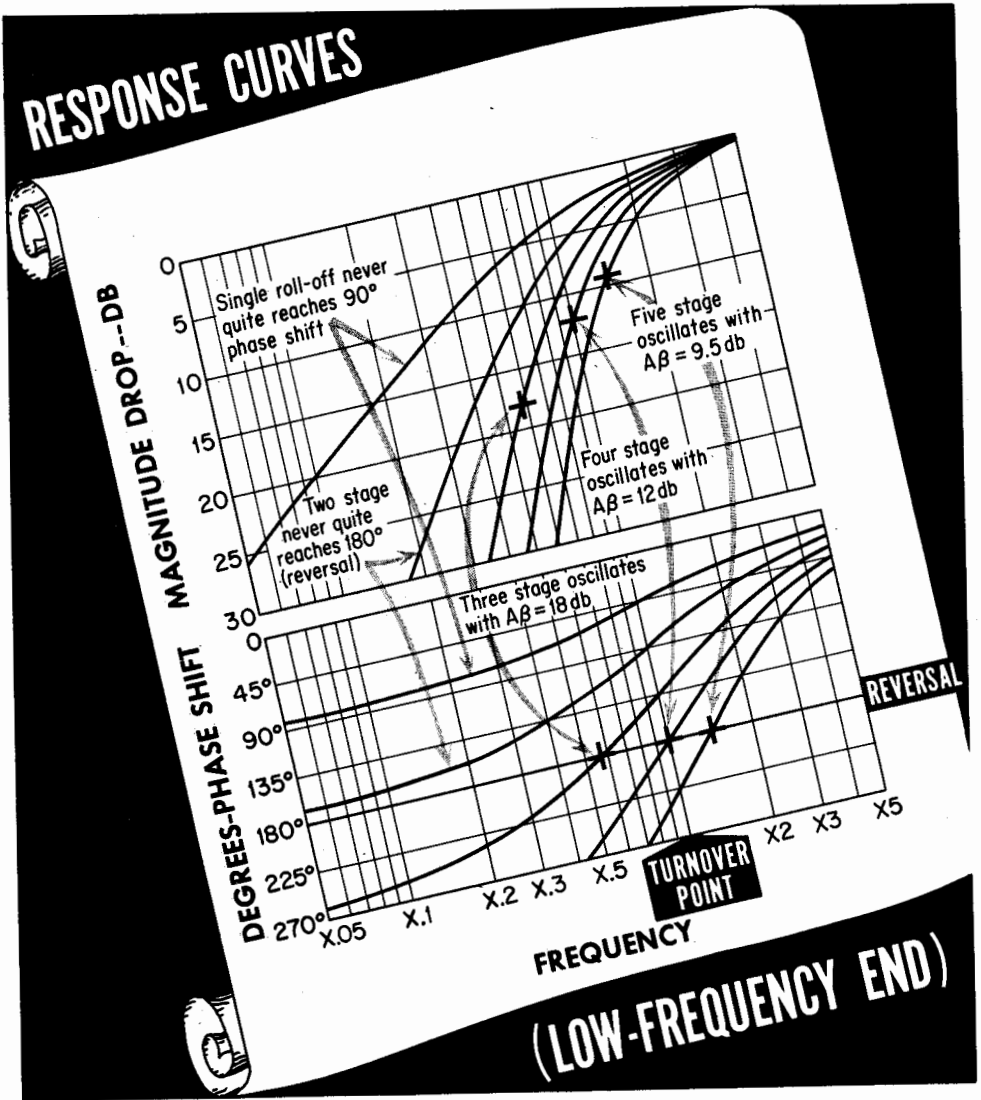

In this way the gain is reduced at the rate of 6 db for every octave with only a little more than 90° phase shift (because the other rolloffs are gradually starting) so it gets the magnitude of $A\beta$ down to much less than 1 before the phase shift reaches 180°.

If similar rolloff points are used at each stage, a three-stage amplifier will start to oscillate when $A\beta$ reaches 18 db (or a loop gain of 8); four stages will only reach a loop gain of 4 (12 db); and five stages limit it to 3 (9.5 db).

FEEDBACK APPLICATIONS

The Cathode Follower

The cathode follower may be regarded as a special example of feedback — all of the output voltage appears in the input circuit, hence $\beta = 1$. If the tube has a working gain of 50 with the resistor values used, an input fluctuation of 51 volts will give an output fluctuation of 50 volts. Following the feedback principle, the effective value in the input circuit of any resistor connected between grid and cathode will be multiplied by 51. This also applies to the reactance of any capacitance between grid and cathode of the tube. The reactance of a capacitance is inversely proportional to its capacitance value, hence the feedback divides the effective capacitance by 51.

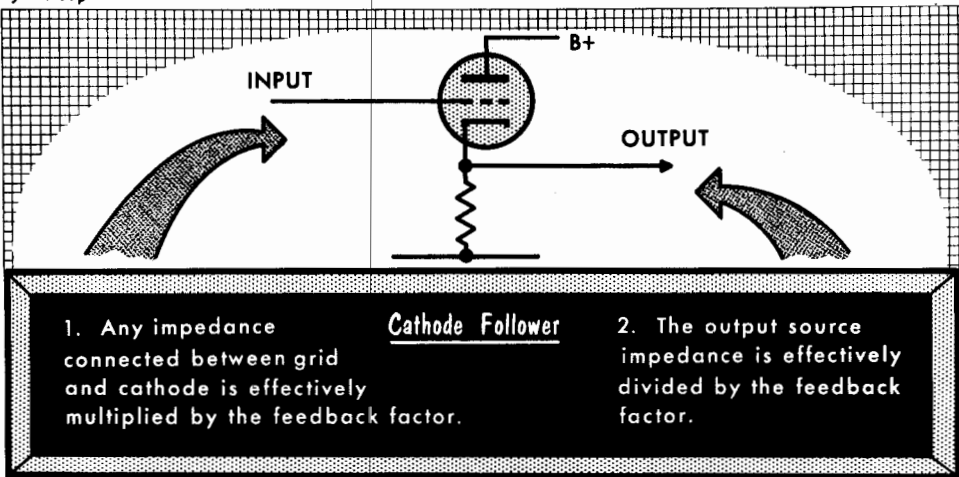
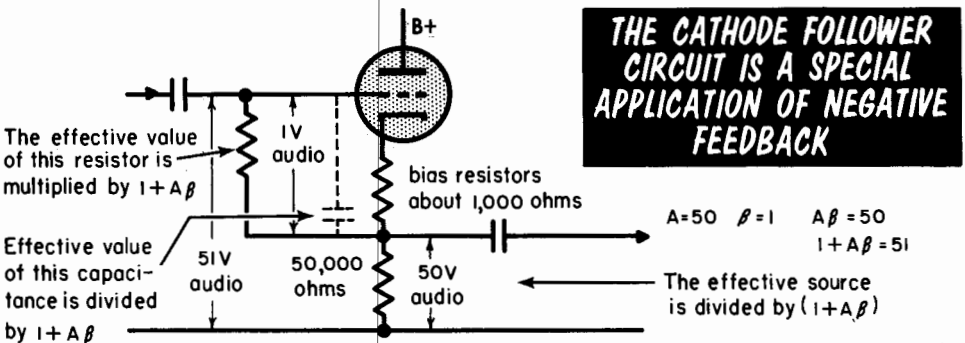

This characteristic makes the cathode follower a very convenient tool for reducing the output impedance of the amplifier. The output impedance in the absence of feedback would be the plate resistance in parallel with the plate load resistor, in this case, about 50,000 ohms. However this gets divided by the feedback factor (in this case 51) to give an effective resistance of less than 1000 ohms.

FEEDBACK APPLICATIONS

Positive With Negative Feedback

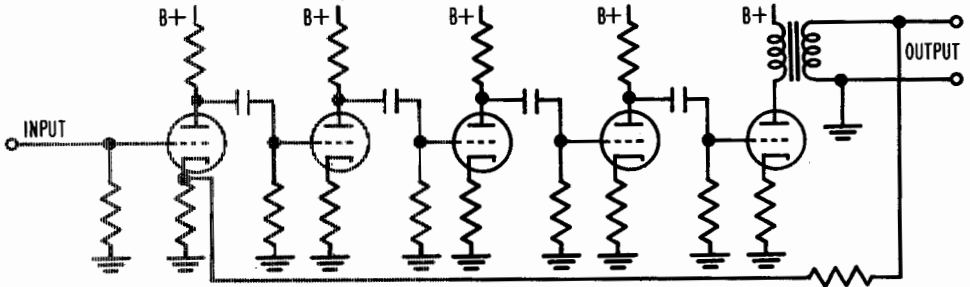

Adding Extra Stages gives More Gain,
so more Feedback could be used,
except for one thing --

EACH EXTRA STAGE ALSO INCREASES THE PHASE SHIFT PROBLEM

As amplifiers use more and more feedback to get the distortion down to even lower proportions, the problem arises of getting enough amplification to "throw away." The more gain required, the more stages that have to be added, and the more possibility of phase shift we encounter.

One way of achieving the extra gain without adding extra stages is to use *positive* feedback. Care must be taken to see that the beneficial effects of the negative feedback — reduced distortion — are not cancelled in the process. The secret is to use positive feedback to boost the gain in a part of the amplifier that has very little distortion. Then increased negative feedback can be used over the whole amplifier to reduce distortion elsewhere.

Use of Positive Feedback Avoids Adding of Extra Stages

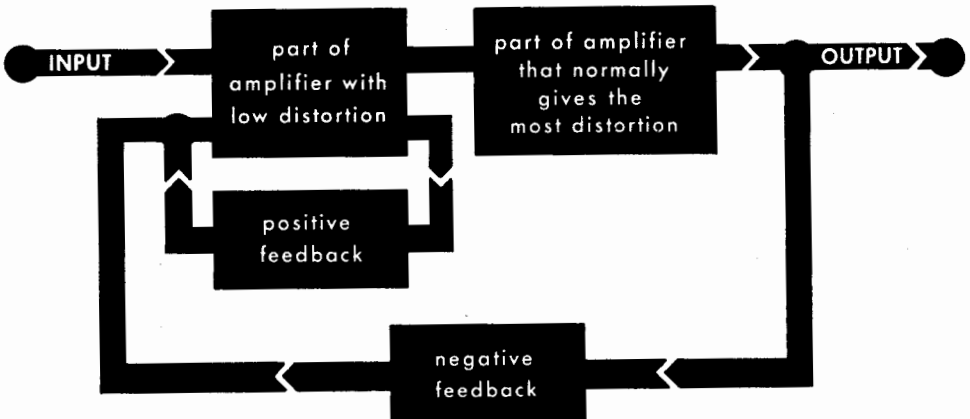

FEEDBACK APPLICATIONS

Positive with Negative Feedback (contd.)

Positive feedback can only be used over one stage in order to avoid oscillation. An easy way to accomplish this positive feedback is to couple cathode bias resistors of two consecutive stages in the earlier part of the amplifier, where the distortion is small.

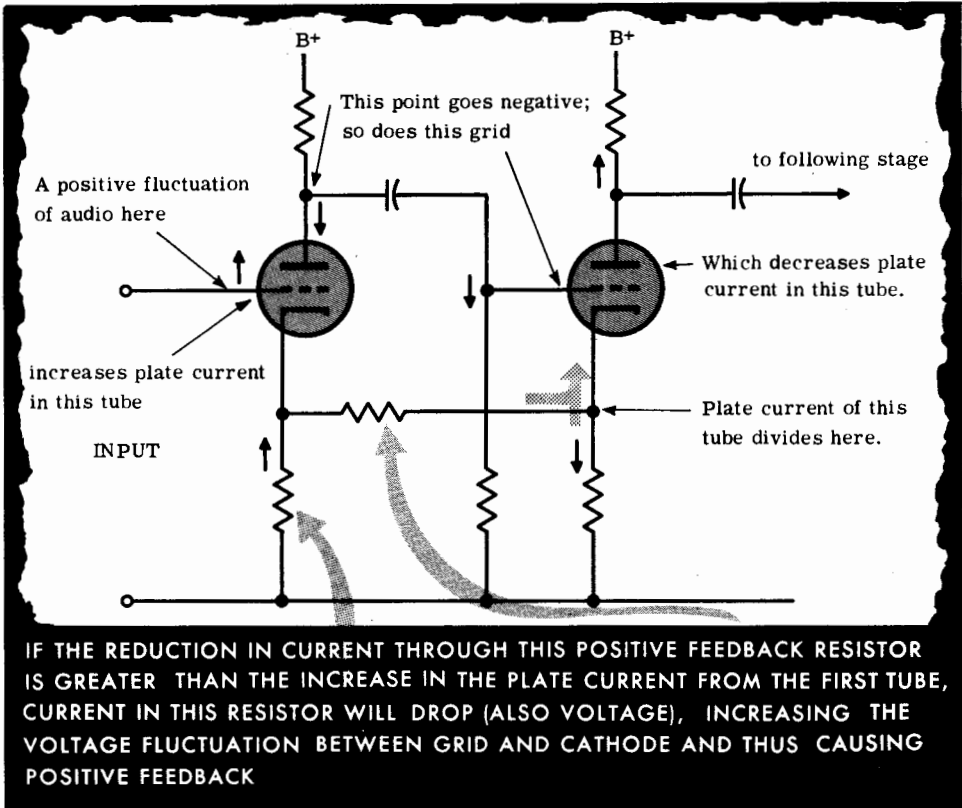

A momentary positive fluctuation at the grid of the first stage will produce a momentary negative fluctuation at the plate, which is passed on to the grid of the following stage. This produces another positive fluctuation at the plate of the second tube. At the same time, the negative fluctuation at the plate of the first tube, resulting from increased plate current, will be accompanied by a positive fluctuation at its cathode. Similarly, a negative fluctuation appears at the cathode of the second tube. The fluctuation at the cathode of the second tube is much bigger than that at the first stage. Connecting the resistor between the cathodes will allow some of the fluctuation from the cathode of the second stage to cancel the fluctuation at the cathode of the first stage.

FEEDBACK APPLICATIONS

Positive with Negative Feedback (contd.)

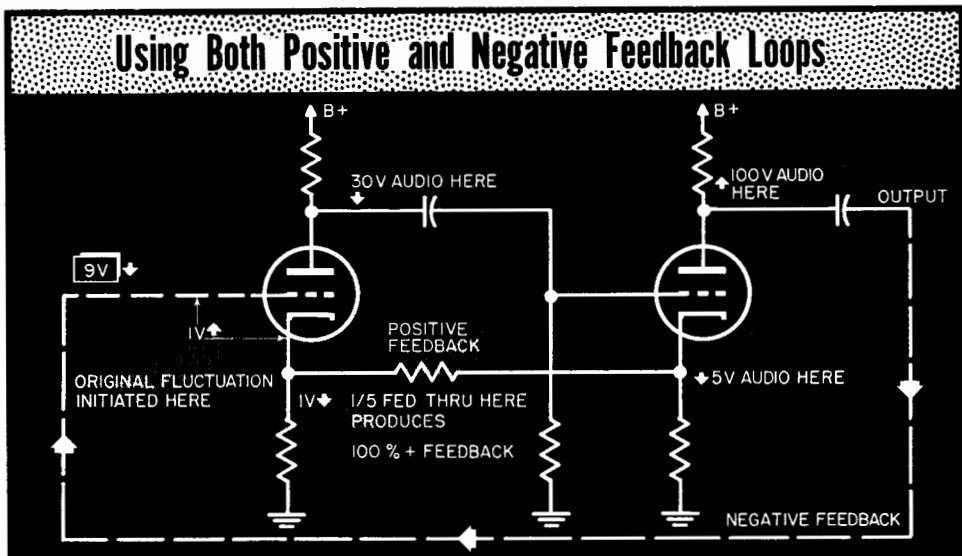

Because of amplification, positive and negative feedback, an input voltage of 9 volts is required.

If the voltage fluctuation fed back caused the cathode of the first tube to move negative by as much as the positive initial fluctuation at its grid, oscillation would take place. (A negative fluctuation at the cathode is equivalent to a positive fluctuation at the grid, hence feedback would provide the total input.) If we use two feedback loops, one positive and one negative, things are not so difficult. Without the negative loop, the initial voltage between grid and cathode of the first stage could feed back enough to cause oscillation, but negative feedback supplies a voltage at the grid that opposes the the initial fluctuation, preventing oscillation from taking place.

Assume that we have an initial fluctuation of 1 volt between the grid and cathode of the first stage. The positive feedback at the cathode that could cause oscillation would also be 1 volt. Now suppose that we provide an amount of negative feedback that *in the absence of the positive feedback* would give a 20-db (10:1) gain reduction. If the positive feedback were not present, we should require a total input of 10 volts instead of 1 volt, the additional 9 volts being required to offset 9 volts negative feedback to the cathode. When both the positive and negative feedback are used, however, the resultant voltage or the feedback effect at the cathode is only 8 volts of negative feedback. This means that the total input need only be 9 volts instead of 10 volts, and that the positive feedback has reduced the amount of gain lost by 10:9 (very nearly 1 db). Alternatively, we could say that when the negative feedback is added, the effect of positive feedback that could increase the gain of the stage to infinity and cause oscillation is reduced to an increase of less than 1 db.

FEEDBACK APPLICATIONS

Special Output Circuits

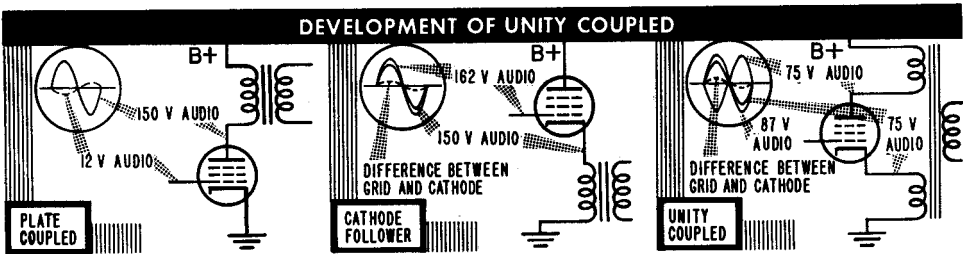

Until feedback came along, the choice for output tubes was between triodes and pentodes. Pentode operation is much more efficient in terms of audio power output for the power input, but it is far more critical of being operated with exactly the right load resistance value than when the same tubes are triode connected.

This led to two basic variations in output circuits, although many further minor variations have developed. The first, called "unity coupled," can best be thought of as a "half-way" cathode follower. Assume that we use a pentode tube that needs a 12-volt audio input to produce a 150-volt output across the load coupled to the plate. To go wholly cathode follower would require an input *voltage* of $150 + 12 = 162$ volts to get the power represented by 150 volts across the load coupled in the cathode circuit. But by coupling the load so that the plate circuit feeds half the power and the cathode half, an audio voltage of 75 volts will appear at each. Now the input audio voltage needed is only $75 + 12 = 87$ volts.

To work as a pentode, the screen must always be at a constant voltage "above" the cathode. This can be achieved by using a multiple-wound transformer. One push-pull primary connects to the cathodes of the tubes, with its center tap to the ground. The other, of exactly equal turns, connects to the screen, with its center tap to B+. This insures that the audio voltage on the screen is the same as that on the cathode. For the plate to deliver its half of the power, it must produce an equal but opposite voltage, so the plates are "cross-connected."

**ONE PRACTICAL
UNITY-COUPLED
PUSH-PULL
CIRCUIT**

VOLTAGES (A) AND (B)
EACH 87V AUDIO

VOLTAGES (C) AND (D)
EACH 75V AUDIO

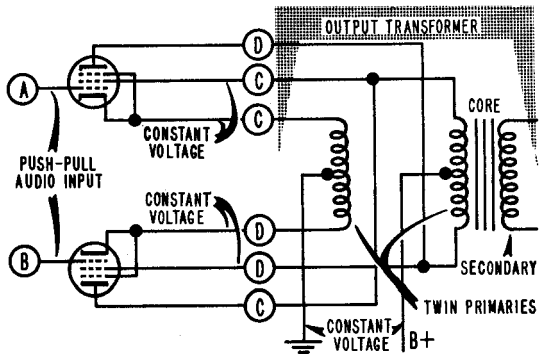
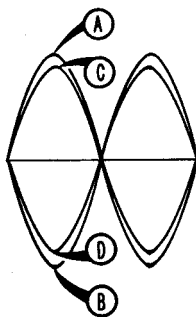

FEEDBACK APPLICATIONS

Special Output Circuits (contd.)

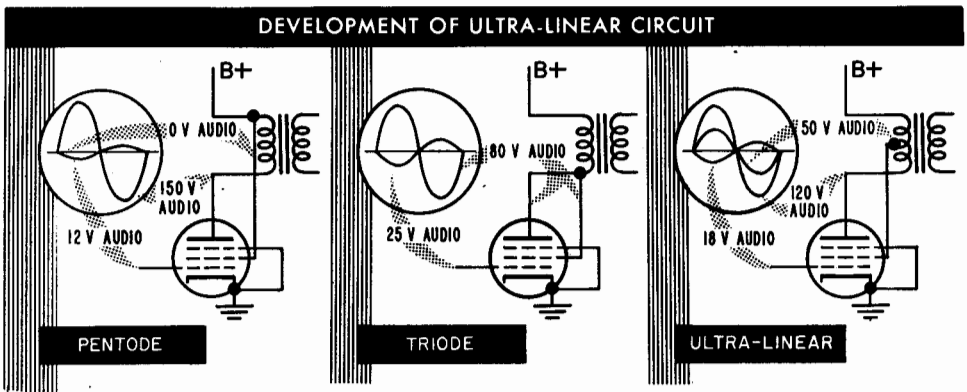

The other special output circuit is called *ultra-linear*. We can visualize the operation as half-way between pentode and triode connection. When a tube works as a pentode, the screen voltage remains steady. The only changing voltages in the tube are the grid and plate potentials. To make the same tube work as a triode, the screen is connected to the plate. This means that when the grid goes positive, the plate current rises, making the plate voltage drop. As the screen is also connected to the plate voltage, this goes negative, tending to offset the plate current rise.

Connecting a pentode to make it work as a triode is like applying negative feedback from the plate to the screen. For ultra-linear operation, the screen is connected to a tapping on the output transformer winding so its audio voltage swings the same way as the plate, but not as *much*. Thus ultra-linear can be regarded as using less negative feedback from plate to screen than occurs to convert the pentode to triode operation. This means that the advantages, too, are split. Most of the efficiency of pentode working is retained, without its being so critical of having the correct output load resistance.

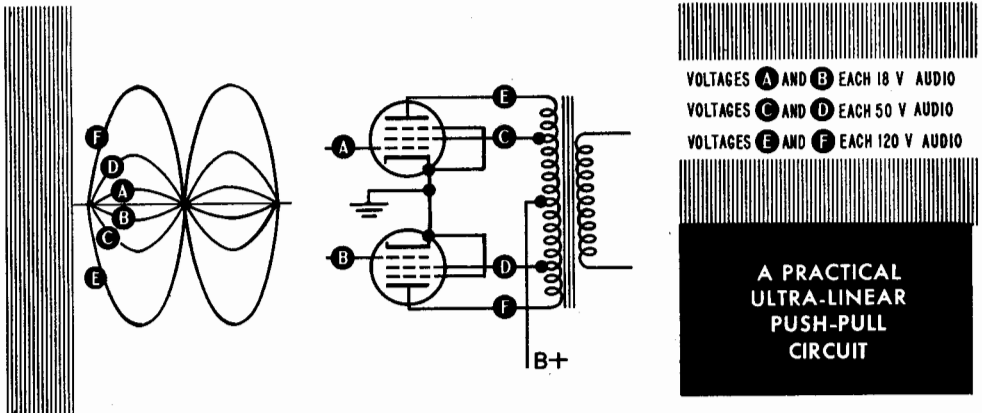

CONTROLS

Gain Control

It is easy enough by one means or another to get as much amplification as we want. In fact, if we are not careful, we will go on adding amplification and end up with too much. For this reason, we need some means of controlling amplification, called a *gain control* or a *volume control*. A simple volume control consists of a resistor with a slider riding on it. It is called a *potentiometer*, because it is a device that allows the *potential* at the slider to be varied.

The first idea for a volume control was to put this potentiometer across the output of the amplifier and take the connection to the loudspeaker from the slider and one end. This varies the amount of power delivered to the loudspeaker, but there is one serious disadvantage. If the amplification is too great, the amplifier will distort the signal, and turning down the control will merely adjust the loudness of the *distorted* program.

The next obvious place to put the volume control would be at the input end of the amplifier. Turning down the volume would then eliminate distortion. However, all amplifiers have a limited *dynamic range*. At the input end, the problem is noise, not distortion. Putting the gain control at the front end of the amplifier, means the loudspeaker gets all the noise amplified up from the input stage (which is usually the point at which noise limits dynamic range). For this reason, the best place to connect a gain control is somewhere in the middle of the amplifier.

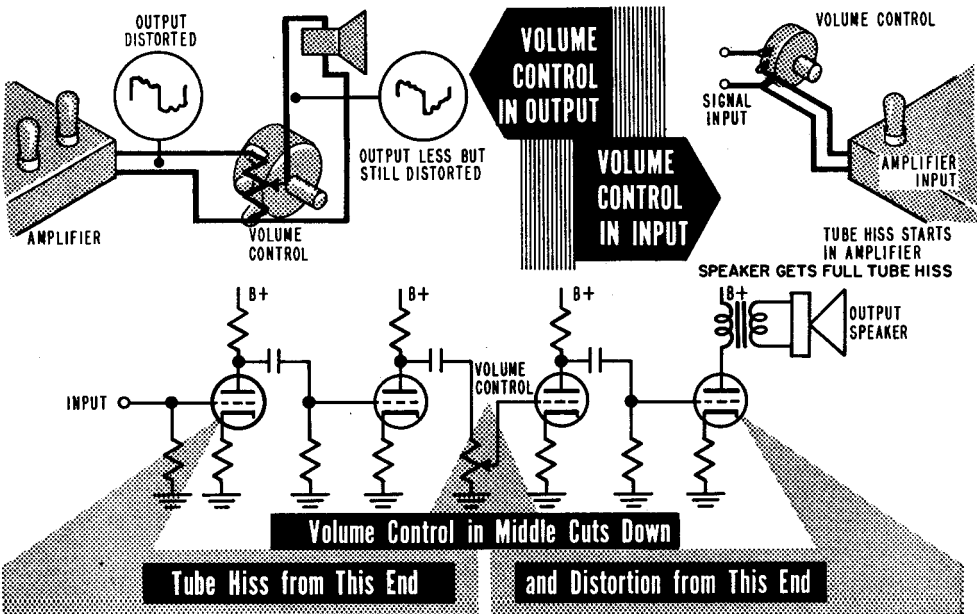

CONTROLS

Gain Control (contd.)

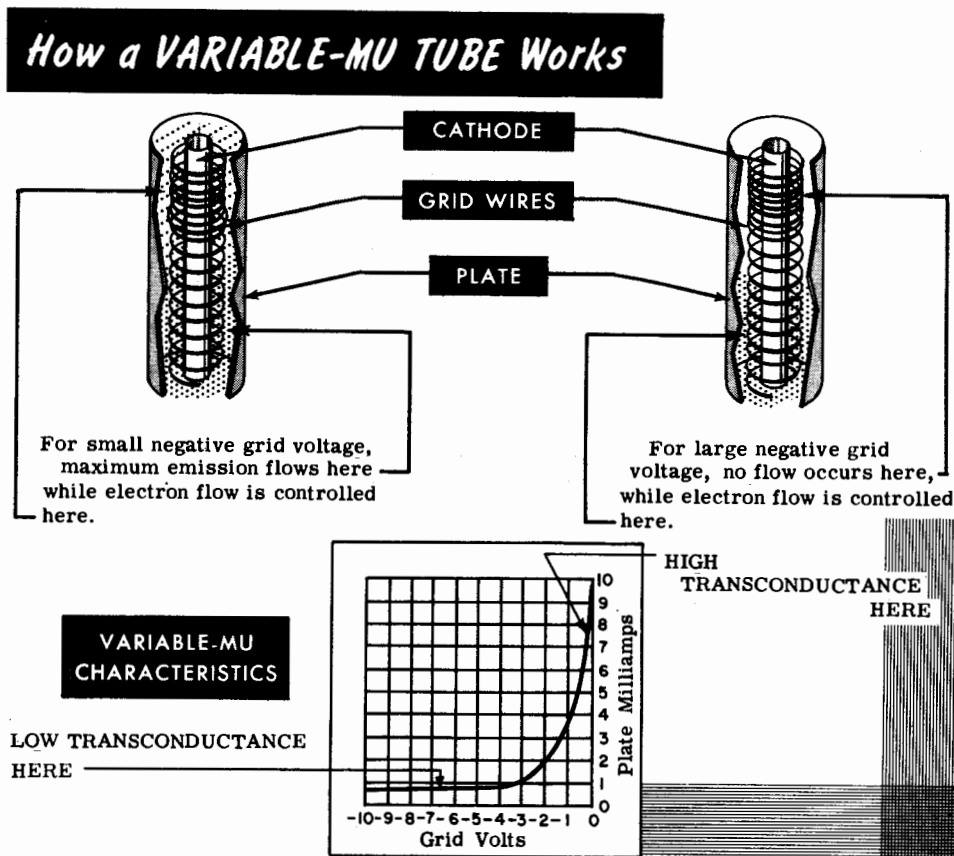

Gain can also be adjusted by altering the operating conditions of a tube, especially if we use a special kind of tube with a considerable amount of curvature in its characteristic. These tubes do not have uniform spacing of the wires that make up the control-grid. This construction produces a tube whose transconductance varies considerably with grid bias voltages. When the grid voltage is only slightly negative, it has practically no effect on electrons passing through the wider part of the grid mesh, but it does influence the number of electrons passing through the closer part of the grid mesh. (In this range, the tube has a high transconductance.)

Making the grid more negative prevents any electrons at all from passing through the closer part of the grid mesh. Those passing through the wider part are subject to less control, and the tube acts as if it had a much lower transconductance. If the change in the spacing of the grid wires is gradual, adjustment of the grid voltage will give a very smooth change of gain as the bias is changed.

CONTROLS

Automatic Volume Control (Compressor)

The circuit shown will provide changes in gain with variation in the grid bias of the tube. It can be easily converted to an automatic volume control by sampling the output and rectifying it to produce a d-c voltage proportional to the loudness at the moment. This d-c is then used as a bias for the variable gain stage with the result that louder program material produces a bigger negative bias reducing the amplification.

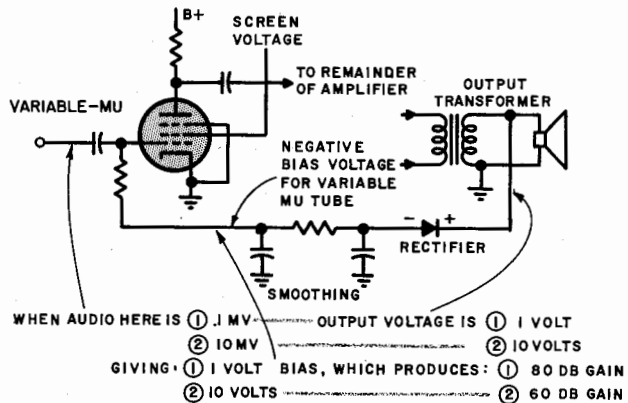
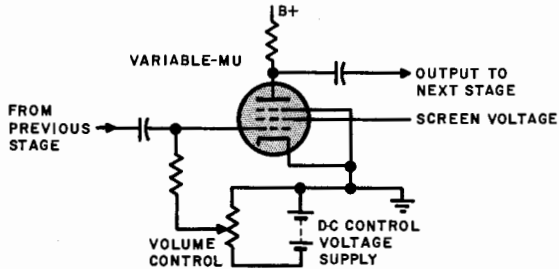
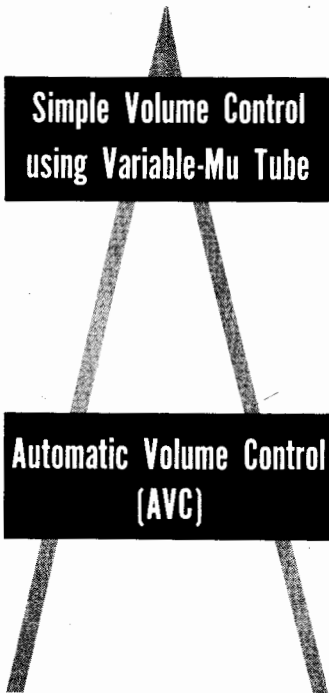

What this circuit does is to reduce the dynamic range of the program. Suppose that an input of 0.1 millivolt will produce an output of 1 volt, which biases the tube to 1 volt negative. This is not sufficient to change its transconductance, so the amplifier works at full gain — in this case, 10,000.

When the output reaches 10 volts, however, the bias for the variable-gain tube has increased to -10 volts. This will reduce the overall gain of the amplifier by a factor of, say, 10:1. The overall gain is now only 1000, instead of 10,000, and the input required to produce the 10-volt output is not 1 millivolt, but 10 millivolts. In this way, the “compressor” has “squeezed” the program material so that a range from 0.1 millivolt to 10 millivolts at the input (40 db) is compressed into a range from 1 volt to 10 volts at the output (20 db).

CONTROLS

The Volume Limiter

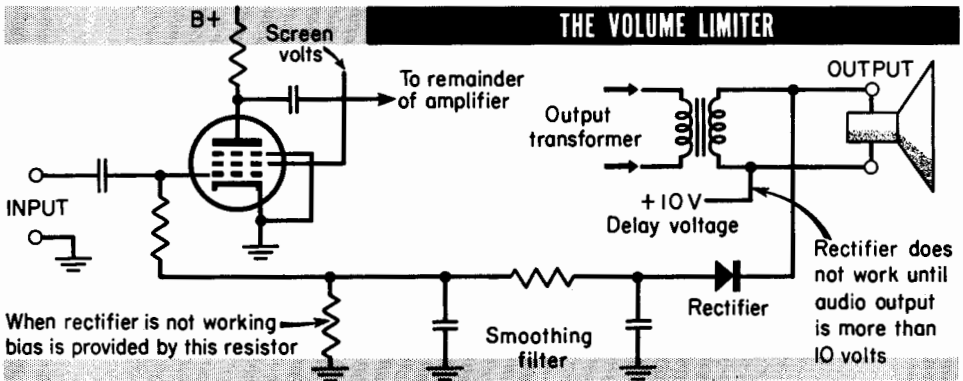

This type of circuit can also work as a volume *limiter*, rather than a volume compressor. It may not be desired to restrict the dynamic range, but merely to make sure the output stage of an amplifier does not overload, causing distortion. What we want to do is turn the gain control down whenever a very loud passage comes through. In this case, the output is rectified in the same way as before to produce a negative bias. The negative bias is compared to another d-c voltage that corresponds to a point below the maximum output that can be allowed. No change in the bias of the gain-control tube occurs, until this *delay voltage* is reached. As soon as the output exceeds the delay voltage, the grid of the gain-control tube goes negative quite rapidly, turning the volume back, and insuring that no distortion occurs.

Both the volume compressor and the volume limiter really use a kind of feedback. The difference from the ordinary feedback that we have discussed is that the audio itself is not fed back, merely a d-c voltage taken from it. The fact that this voltage is fed back means that care has to be taken in the design of this kind of circuit (as it is with a feedback amplifier) to make sure that oscillation does not occur. The audio has to be properly rectified, and any a-c components filtered out so that the d-c applied to control the grid will not start oscillation.

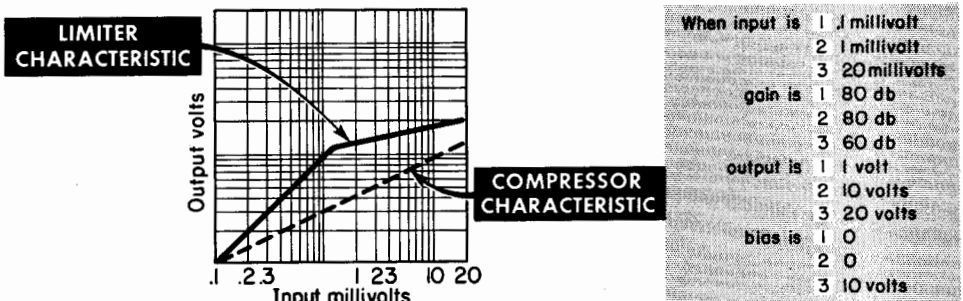

CONTROLS

Tone Controls

Another kind of control often required in amplifiers is the *tone* control. This name is used to describe an arrangement that will continuously adjust frequency response, increasing or reducing the high- and the low-frequency output. A tone control usually acts to boost or reduce the frequencies toward one end of the range amplified. (The control for the high-frequency end is called a *treble* control, for audio purposes, and that for the low-frequency end is called a *bass* control.)

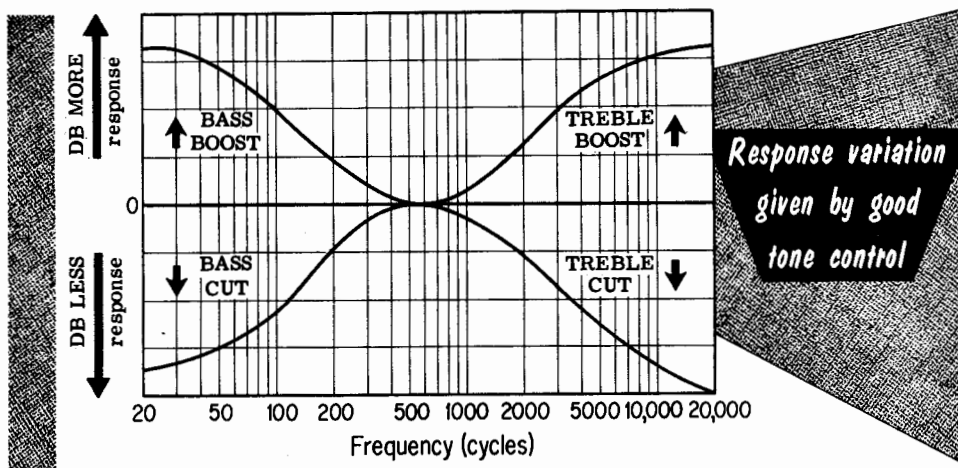

A fixed circuit that adjusts frequency response to a curve previously decided upon is called an *equalizer*. (Sometimes equalizers may also be required to remove undesired resonances, which requires another kind of circuit.) These circuits are called equalizers, because they are usually needed to equalize for the characteristics of something else in the system: to correct for the response deficiencies of a microphone, recorder, pickup, playback head on a tape machine, a loudspeaker, for the studio or listening-room acoustical characteristics, or in some instances, for personal preference in the kind of sound desired.

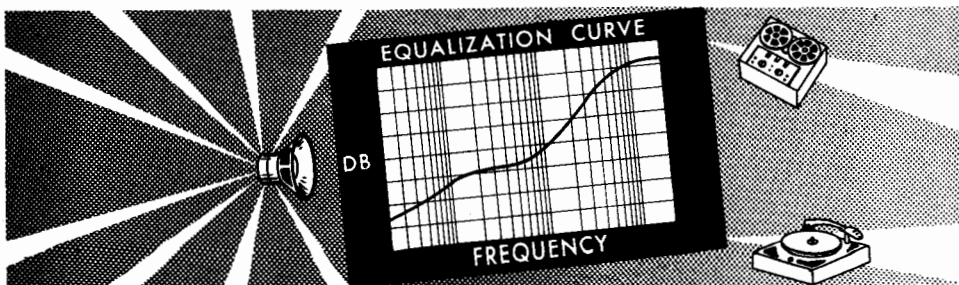

CONTROLS

Tone Controls (contd.)

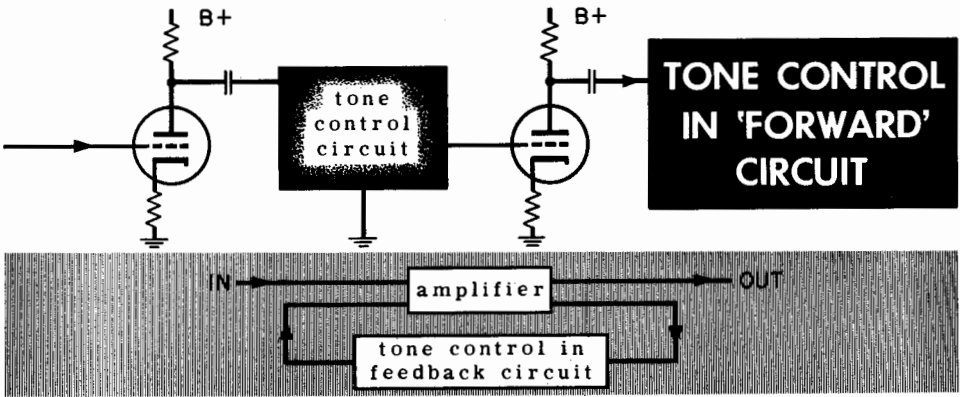

Tone control and equalizer circuits can work in one of two basic ways. One system adjusts the frequency response of an amplifier on the way through, while the other adjusts it by varying the amount of different frequencies fed back. There are also two kinds of adjustment to the response. One is a reduction of some frequencies in comparison with the rest. The other is an accentuation or boost of some frequencies compared with the rest. Unless we add another stage the amplifier has only a certain amount of total gain and a tone-control circuit containing only resistances, capacitances, and possibly inductances, cannot give us any *more* gain. For this reason the only way to accentuate some frequencies is to cut down frequencies in the rest of the range.

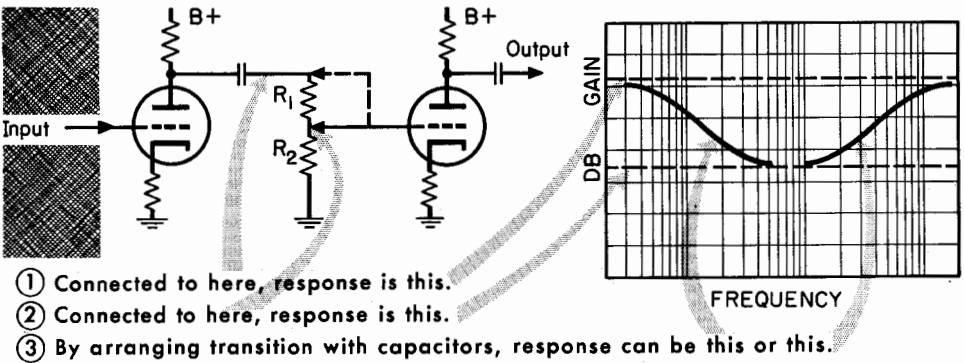

CONTROLS

Tone Controls (contd.)

A simple way to achieve tone control is to use a voltage divider between two stages, rather like the method used for volume control. (Here, however, the voltage divider is fixed rather than variable.) A variable voltage divider connected in parallel with the fixed divider through two small capacitors will affect the high frequencies only. (This occurs because the small capacitors block current to the resistors in the variable voltage divider at lower frequencies.)

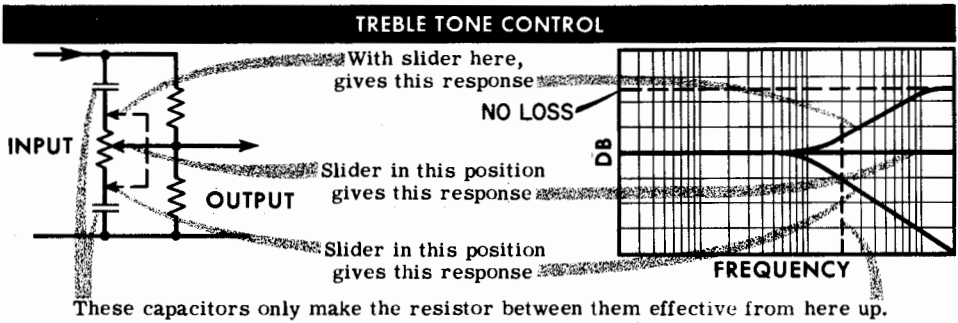

Control of the low frequencies can be achieved by inserting capacitors in series with the resistor used for dividing the audio voltage. A capacitance in series with the lower resistor in the drawing will develop a considerable audio voltage, particularly at the low frequencies, resulting in a larger voltage being passed on to the next stage at the extremely low frequencies than over the rest of the audio range. Putting a capacitor in series with the upper resistor develops the greater part of the voltage at the low frequencies and reduces the amount developed across the lower resistor. This produces an attenuation or loss of the extremely low frequencies.

CONTROLS

Tone Controls (contd.)

Composite Tone Control

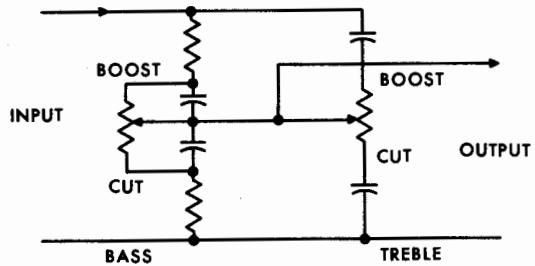

'FORWARD' CIRCUIT

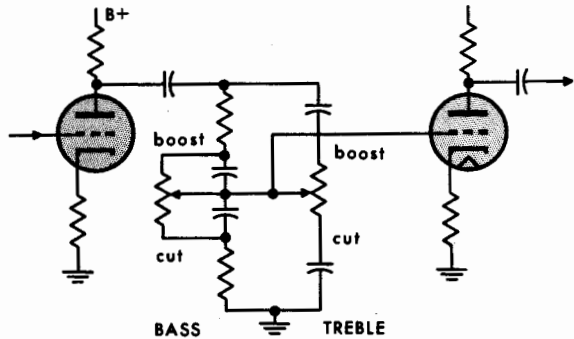

FEEDBACK CIRCUIT

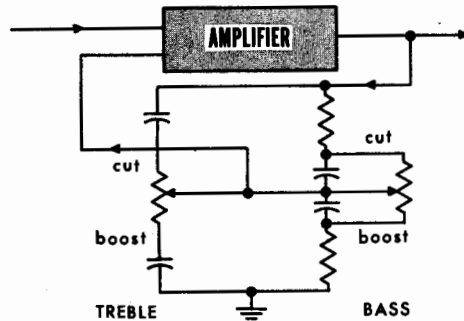

By combining the arrangement and using a potentiometer across the two capacitors, we provide a continuous adjustment that will go from bass boost to bass cut. Most modern tone control circuits combine the two arrangements with two controls, one for the treble boost and cut, the other for bass boost and cut.

An alternative system of tone control uses feedback. In this case, a similar control arrangement is placed in the feedback network. The action of this control is the reverse of that just discussed. If more of the high frequencies are fed back, the amplification at the high frequencies is reduced, resulting in treble cut. If less of the high frequencies are fed back, then the amplification of the high frequencies is increased, resulting in a treble boost.

QUESTIONS AND PROBLEMS

1. How do coupling capacitors and circuit self-capacitance affect the performance of feedback circuits? At a certain frequency, the phase shift due to coupling capacitors, of which there are four, is 45° , 55° , and 30° for the first three. How much phase shift can be allowed in the fourth capacitor at this frequency, for what is nominally negative feedback to become positive?
2. What is a Nyquist diagram? If the basic quantity plotted on the polar diagram is loop gain, how can the diagram be used to show the response of the feedback factor and the overall response shaping?
3. What is gain margin? Explain how an amplifier that is stable with feedback connected can become unstable if its gain is increased, or if the feedback amount is increased.
4. What is a cathode follower? Explain its action in terms of feedback action. A certain tube, using a plate load resistance of 100,000 ohms, has an a-c resistance of 60,000 ohms and gives an amplification of 48. Rearranging this as a cathode follower; calculate (a) the input impedance with a grid return resistor of 220,000 ohms and (b) the output source resistance (a-c).
5. How can positive feedback be used with negative feedback to get certain improvements? State the specific precautions necessary in adopting this method.
6. Positive feedback is increased just to the point where oscillation commences, without negative feedback. Overall negative feedback that reduces gain by 14 db when the positive feedback is not connected is also used. By how much will the gain change when the positive feedback is now connected?
7. Discuss the relative merits of different positions for a gain control or volume control that lead to choice of an ideal, stating clearly the objections to other positions.
8. Describe the action of a special type of tube that is used to provide automatic volume control electronically. Show how the same basic arrangement can be modified to act as a volume limiter, rather than as a compressor.
9. What is the function of a tone control? Discuss simple circuits that will provide the basic variations required.
10. Why is equalization necessary? Name various locations where an equalizer is required. In what way does an equalizer differ from a tone control?

PLATE VOLTAGE SUPPLY

Sources of Power

In all our discussions thus far, we have described amplification in terms of tubes and other components that need voltages applied to them to make them work. We have not considered where these voltages come from, but they all need to have the right voltage supplies, whatever they may be.

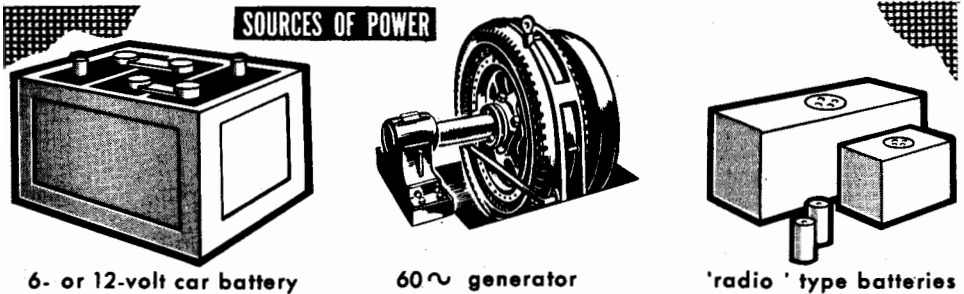

In most modern equipment these supplies come from an electrical power company, most of which deliver a voltage of 117 volts at 60 cycles. Other supplies are sometimes used; for example, in aircraft, where the frequency is not 60 cycles, but 400 cycles, and in automobiles, where the supply is not a-c but d-c, at 6 or 12 volts from a battery. We are principally concerned with 117-volt 60-cycle a-c sources. If the supply is a-c of a different frequency, as in aircraft, the details of the design will be altered but the principles will be the same. Where the supply is d-c, as in automobiles, and in a few isolated locations where the power company supplies it at a higher voltage, such as 110 volts, a different kind of power supply circuit is required. The convenience of a-c as a source of supply is that the voltage can easily be stepped up or down by means of a power transformer.

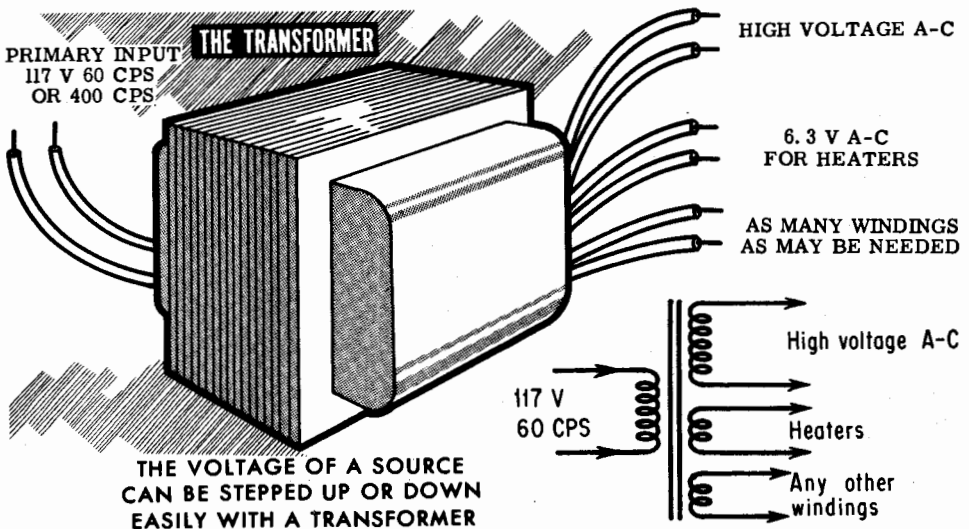
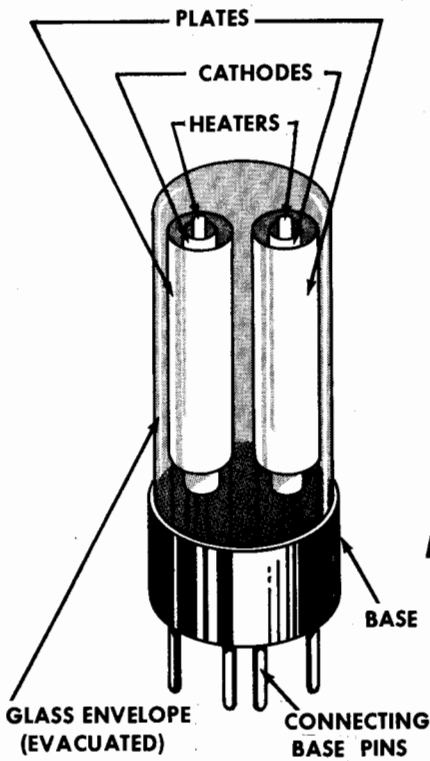
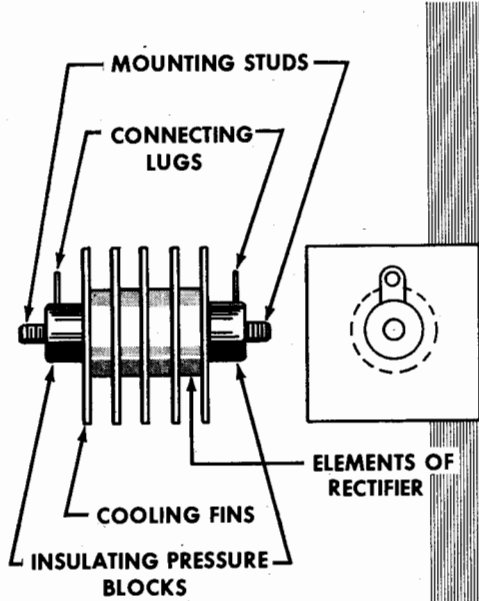

PLATE VOLTAGE SUPPLY

Rectification



Tube Rectifier



Barrier Layer Rectifier



ELECTRON FLOW IN THIS DIRECTION

We can get the desired d-c voltage for plate supplies by transforming a-c and rectifying it. Two kinds of rectifier are used for audio amplifier circuits: the thermionic rectifier, which employs one or possibly two electronic diodes in one envelope; and the barrier-layer rectifier, which uses the rectifying properties of copper oxide, selenium, germanium, or silicon. (These materials are listed in the order of improving efficiency and also their sequence of development. Choice of which kind of rectifiers to use usually depends on the relative cost or the particular space requirements, whichever happens to be the most important.

PLATE VOLTAGE SUPPLY

Rectification (contd.)

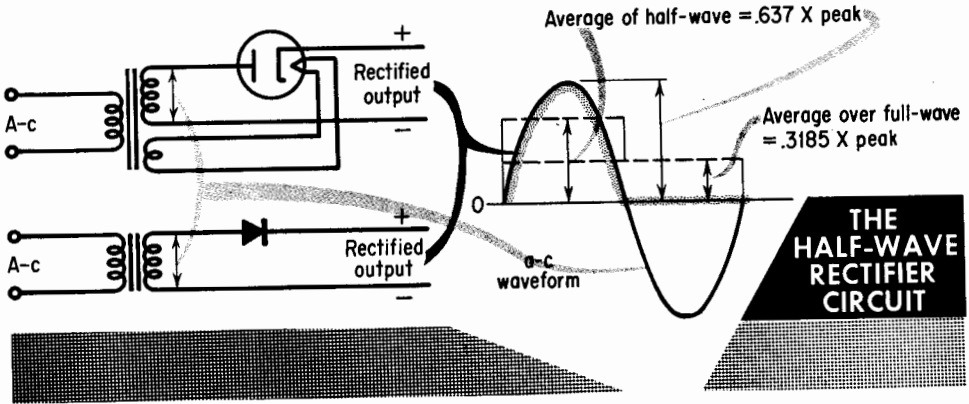

We can use either half-wave or full-wave rectification. Half-wave rectification saves one rectifier component; we only need one diode or one rectifier element. For small plate current supplies, where the current drain is very limited, this circuit is quite convenient. It has, however, the disadvantage that the whole of the current drain has to be passed through the rectifier in a small fraction of *one* half of the cycle. It also needs more elaborate attention when smoothing out the voltage. Where larger plate currents are needed, above say 50 milliamperes, full-wave rectification is almost always used. This enables two current pulses to be taken in every cycle instead of only one, and makes it much easier to smooth out the ripple.

The exact way in which the rectifier works to give the required d-c output voltage depends on the kind of circuit used to smooth out the ripples. If the rectifier is fed straight into a resistance load, the output waveform will be either a succession of half-waves, with a gap for each alternate half-wave, or if full-wave rectification is used, a succession of half-waves end to end. This kind of voltage supply is not suitable for audio amplifiers, because it would result in very considerable hum. For this reason we need to do something to smooth out the ripple component.

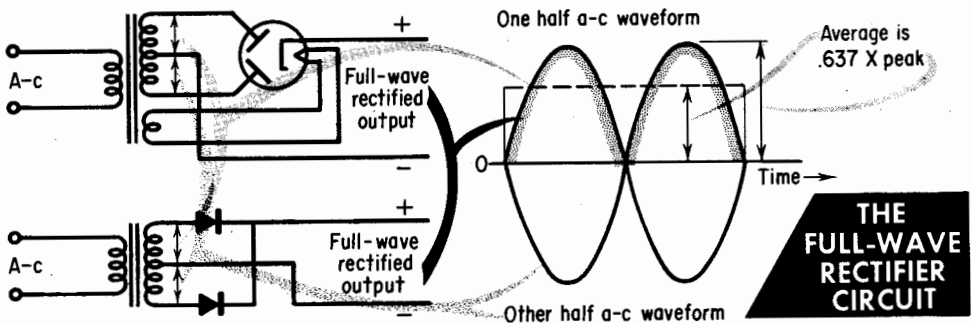
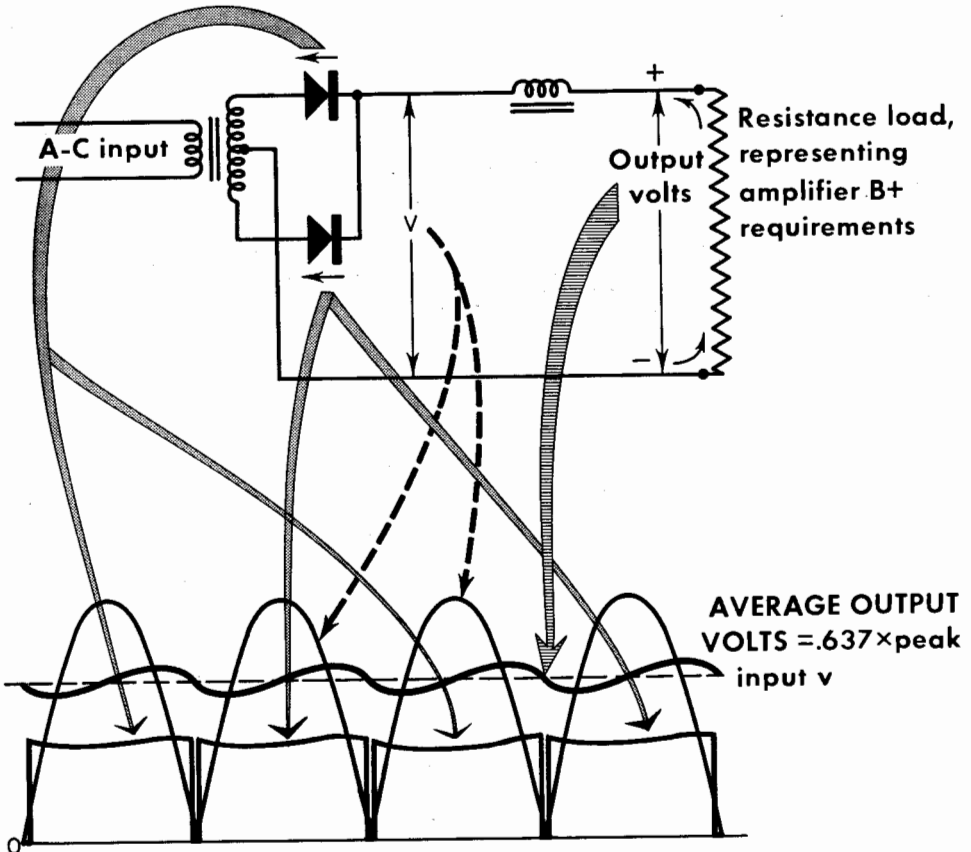

PLATE VOLTAGE SUPPLY

Filtering

CHOKE IS USED TO SMOOTH OUT RECTIFIER OUTPUT



One method of smoothing is to put a choke in series with the feed to the amplifier. If we regard the amplifier as a resistance taking a constant current at a constant voltage, a choke of sufficiently large inductance will pass *almost* constant current and allow a considerable voltage fluctuation across itself. (If an inductance is large, a very large voltage is necessary to produce only a small change in current.) In this case, the voltage at the input to the choke is the same fluctuating voltage that comes out from the rectifier, whereas the output of the choke is an almost smooth d-c because of the almost constant current in the resistance "load."

PLATE VOLTAGE SUPPLY

Filtering (contd.)

The other element of a smoothing arrangement is a capacitor. If we connect a capacitor in parallel with the resistance load that represents the amplifier, the rectifier will charge this capacitor up to the peak value of the alternating voltage. As the wave dips back toward zero, the capacitor will maintain the output current by discharging into the load, thereby keeping the voltage nearly constant between peaks. If only a small current is taken by the load relative to the charge contained in the capacitor at this voltage, the output of a rectifier, using a capacitor in this way, will come very close to the peak voltage of the a-c waveform.

An Input Capacitor May Also Be Used To Smooth Out Output

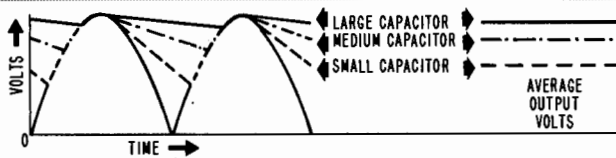
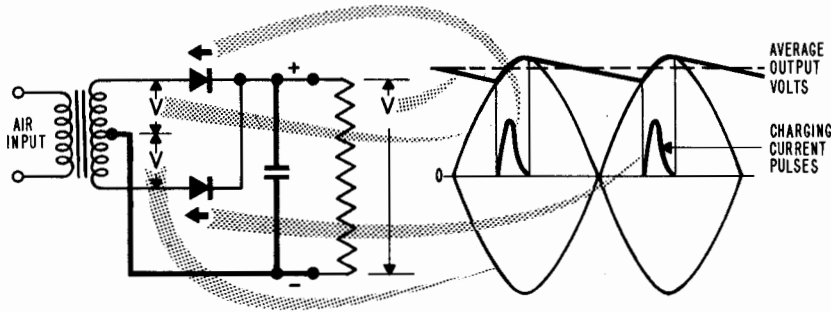

If the capacitor is not large enough to maintain this high a charge over the interval between consecutive half-cycle pulses, the voltage will drop away more during this interval, and the average output voltage will not be quite so high as the peak of the alternating waveform.

A single choke or a single capacitor does not smooth out the ripple completely. The choke has to have a fluctuating current, *however small*, to produce the fluctuating voltage across its terminals. The voltage across the capacitor drops by some amount, *however small*, between charges, before the next pulse comes along to restore the charge. Hence we need further smoothing action to get an adequately smooth or steady d-c and to avoid producing hum in the amplifier.

PLATE VOLTAGE SUPPLY

The Capacitor-Input Filter

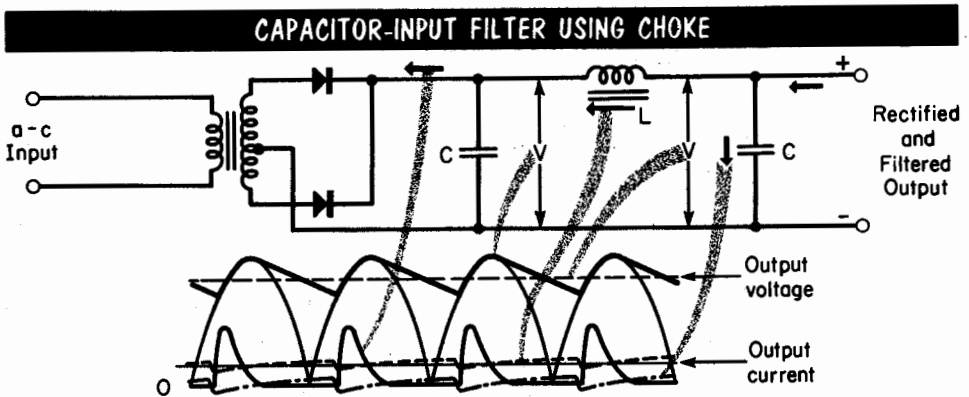

The most common circuit used for smoothing is the *capacitor-input* filter. It produces a starting voltage in the same way as a capacitor connected directly across the load. The load current is then passed through a choke and another capacitor is connected after the choke. Because the fluctuation at the input end of the choke is now quite small, the choke can do much more toward stabilizing the current passing through it. Any residual fluctuations in voltage that still might appear at its output end are "soaked up" by the second capacitor.

For low-current supplies, or even moderately larger current supplies (up to 100 or 200 milliamps in modern amplifiers), a resistor is sometimes used to replace the choke; this is an economy measure. (Resistors are considerably cheaper than chokes, and modern electrolytic-type capacitors can get very large values of capacitance into quite a small space at low cost.) The disadvantage of the resistor is that it produces a voltage drop so that the *rectified* voltage needed is appreciably higher than the required *output* voltage.

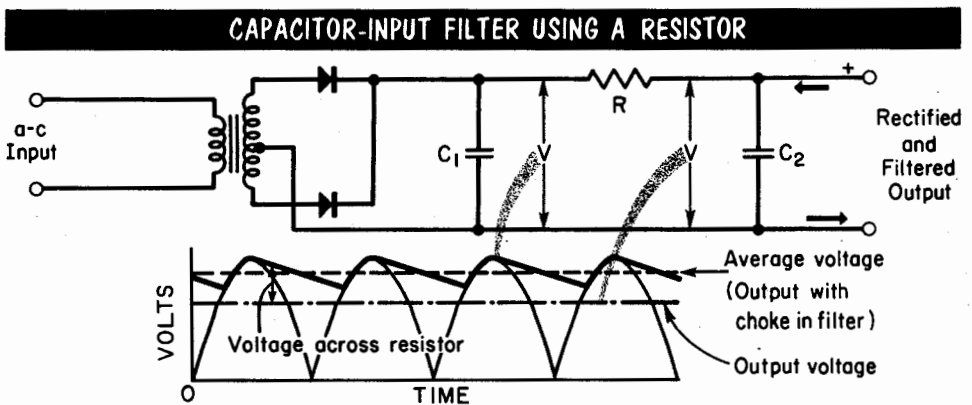
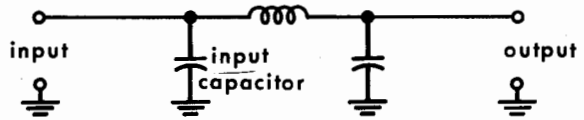

PLATE VOLTAGE SUPPLY

The Capacitor-Input Filter (contd.)

**IN A
CAPACITOR-INPUT
FILTER**



**THE RECTIFIED OUTPUT VOLTAGE ALWAYS
CHANGES WITH THE LOAD CURRENT**

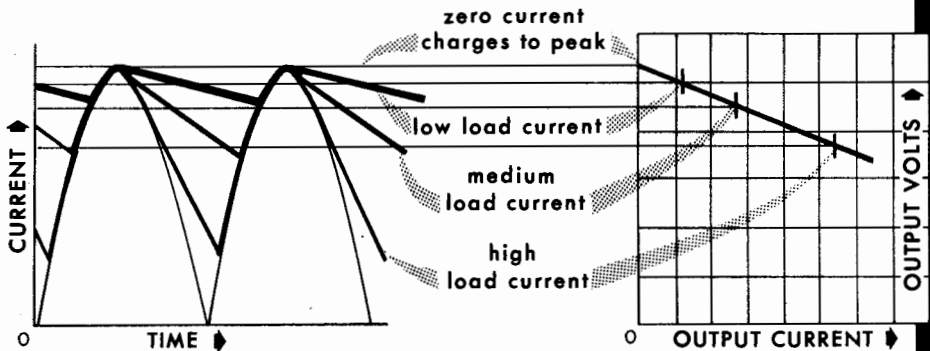

A problem that arises with a capacitor-input filter is that the rectified output voltage always changes with load current. The reason for this is that the load current determines how much the voltage drops between charging pulses. The output voltage is averaged between these peaks and the amount that the voltage drops between them. A larger load current produces a bigger drop, and the average output voltage drops as well. Some kinds of audio circuits require considerable fluctuation in plate current of the output tubes. If the capacitor-input filter is used, the supply voltage also fluctuates with the current. This is where the choke-input filter has an advantage.

PLATE VOLTAGE SUPPLY

The Choke-Input Filter

The Choke-Input Filter

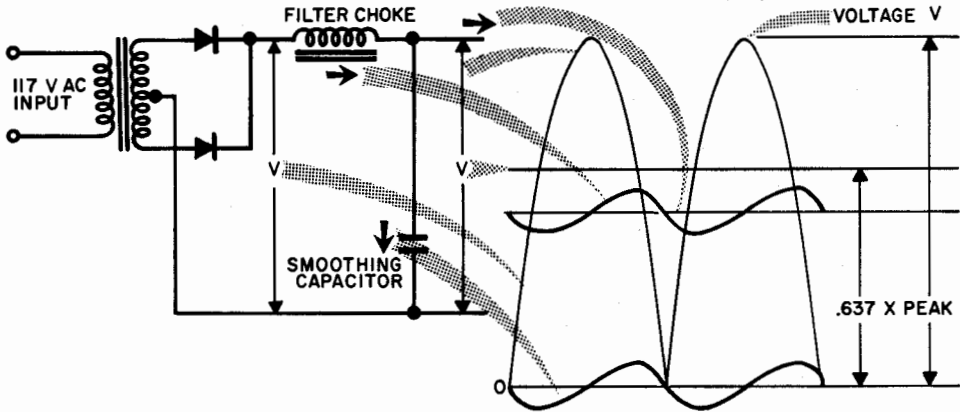

THE OUTPUT OF A CHOKE FILTER
IS ALWAYS $.637$ TIMES THE
PEAK ALTERNATING VOLTAGE
OR $.9$ TIMES ITS RMS VALUE.

The voltage at the output end of the choke (provided its resistance is reasonably low) is constant because the choke averages out a voltage fluctuation at its input end that is always the same — from zero to the peak of the alternating voltage. According to each half-wave of the rectifier waveform, the output of a choke input filter is always 0.637 times the peak alternating voltage which is $(0.637/0.707)$ or 0.9 times its rms value.

In practice, the output will be slightly lower than this figure, owing to the voltage drop in the resistance of the choke. Further smoothing is achieved by means of a capacitor connected at the output end of the choke. It does not act as a reservoir capacitor as in the case of capacitor input, but merely serves to minimize voltage fluctuation by soaking up the slight current fluctuation in the choke.

PLATE VOLTAGE SUPPLY

The Swinging Choke

Another kind of filter circuit employs the so-called "swinging" choke. All smoothing chokes employ iron cores with air gaps that prevent saturation. By properly choosing the size of the air gap, a special action is produced. At low load currents, the core is not saturated, but for higher current it progressively approaches saturation, which makes the circuit act as a capacitor-input filter. Capacitor-input filters produce higher output voltages; hence, the output at the filter can be made to *rise* with increased load current.

At small load currents, the inductance of the choke is sufficient to make the filter behave as a choke-input arrangement, and the output voltage is not more than 0.637 of the alternating peak voltage. As the current drain increases, the choke begins to saturate, and the rectifier starts pulse-feeding the capacitor at the output end of the choke. The circuit then begins to act as a capacitor-input filter and the output voltage rises.

Because the current is increasing at the same time, the output cannot possibly *reach* the peak value of the applied a-c because the drain effect will cause dips between the peaks, but the average voltage *can* rise with a carefully designed filter of this kind. This is useful because it will serve to offset the voltage drop in the supply circuit that always tends to reduce the output voltage with increased load current. If the rise produced by the swinging choke just offsets the losses produced by increased current through the rectifier, the power transformer, and possibly a further smoothing capacitor, the output voltage of this kind of filter will be almost perfectly constant as the load current is changed.

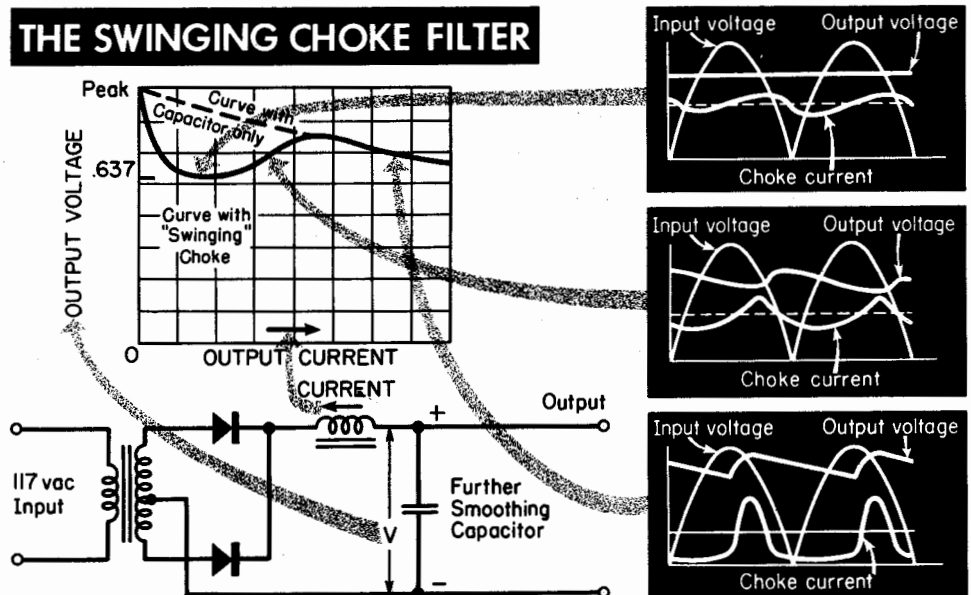
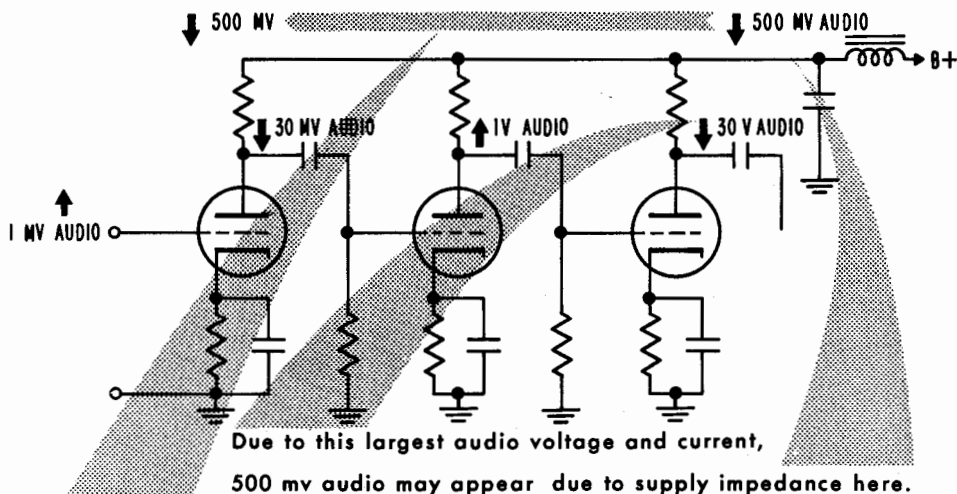

PLATE VOLTAGE SUPPLY

Decoupling (contd.)

Fortunately, high-gain low-level stages do not take much plate current. This means that relatively large-value resistors and capacitors that provide a high degree of ripple reduction can be used without dropping the plate potential appreciably. These additional components are necessary for another reason. We discussed feedback (at the beginning of this volume) as something desirable that we introduce intentionally. Feedback can also be undesirable and be introduced unintentionally. This is one place where this occurs if care is not taken.

UNDESIRABLE FEEDBACK CAN CAUSE OSCILLATION



This voltage gets fed back and is in right 'phase' to add to original 30 mv at this plate, probably causing oscillation. This also may be avoided through the use of decoupling resistors and capacitors.

The normal high-voltage supply has an impedance due to the reactance of the final smoothing capacitor and resistors in the circuit that varies from a few ohms to perhaps several hundred ohms, according to design. Even if this impedance is only a few ohms, the output-stage audio current will probably be a fluctuation of 50 milliamperes or more and the power-supply impedance will produce half a volt or more audio across it. This half-volt of audio superimposed on the high voltage supply, will be injected into the front end stage, unless we provide some means of getting rid of it. The further resistor and capacitor, used to reduce the ripple or hum voltages as well as smoothing, bypass (*decouple*) this audio voltage. For this reason these extra resistors and capacitors are called decoupling elements.

GRID BIAS SUPPLY

Grid Biasing Methods

We have seen how to achieve the correct supply voltage for the plate circuits, but to work in an amplifier correctly, each tube must also have the correct grid bias voltage and, if it is a pentode, the correct screen voltage. There are two ways of providing the grid bias voltage: one method uses a separate supply of fixed voltage. This can be the same as any of the plate supply arrangements, except that the polarity is reversed and very little current is needed.

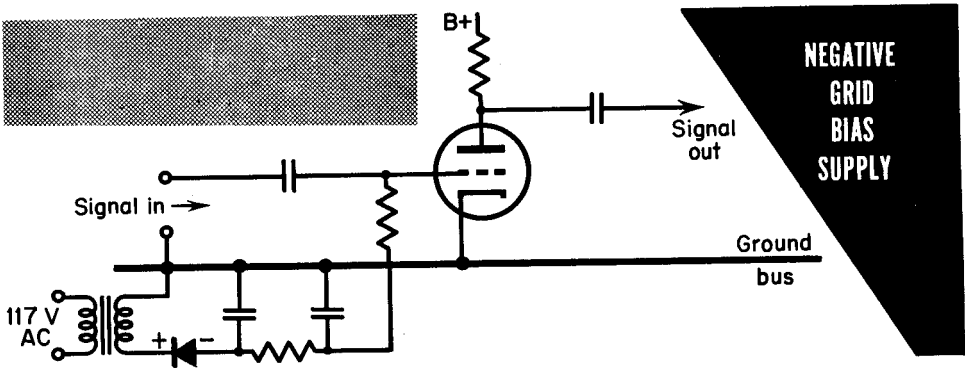

However, the most commonly used method works by making the cathode positive rather than the grid negative. As far as the tube is concerned, the effect is the same. A small resistor, from 100 to 5000 ohms, according to plate current and the bias voltage required, is connected between cathode and ground. This makes the cathode positive with respect to ground by an amount that varies with the plate current. Because one end of the grid resistor is connected to ground, the d-c or bias voltage on the grid is that of ground. For this reason, making the cathode positive with respect to ground will be the same as making the grid negative from cathode.

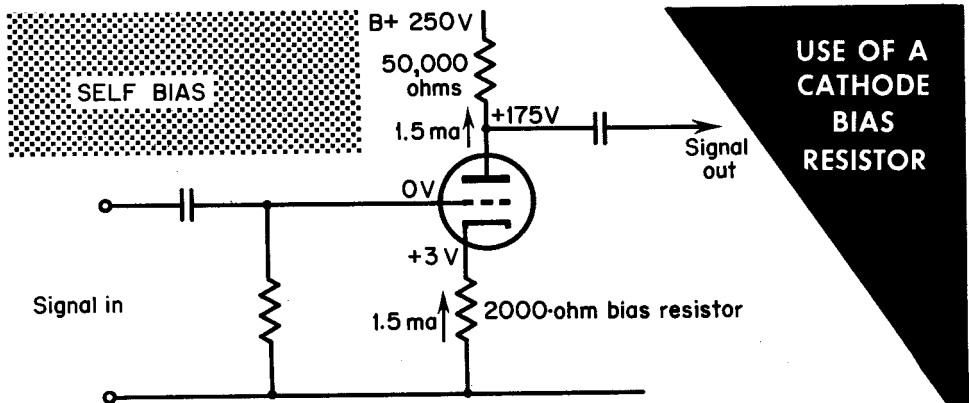

GRID BIAS SUPPLY

Self Bias

Assume that the cathode resistor is 2000 ohms. If the plate current is 1 milliampere, the grid bias will be 2 volts, and so on. We can now find the operating point of this value of cathode resistor by plotting a curve on the tube characteristics. We mark the points where the 2-volt bias curve crosses 1 milliampere, where the 4-volt bias curve crosses 2 milliamperes, and so on. The operating point of the tube is the point at which this curve crosses the load line for the chosen value of the plate resistor.

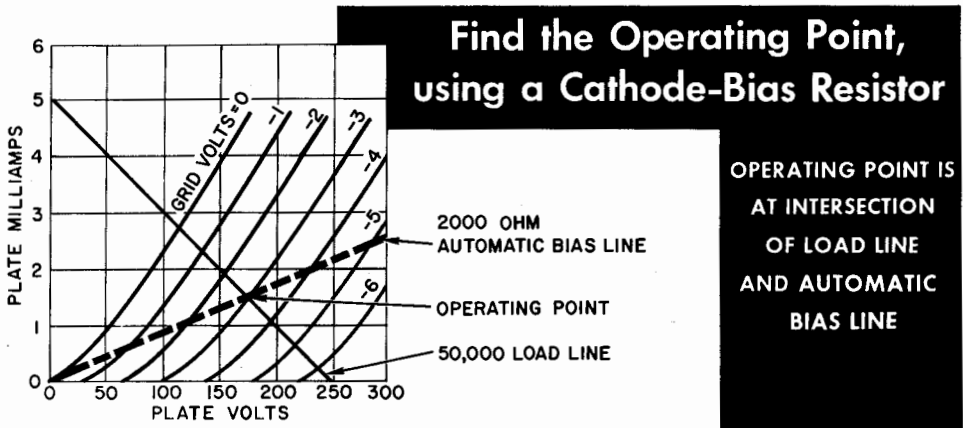

Fluctuations of Plate Voltage affect a Self-Biased Circuit

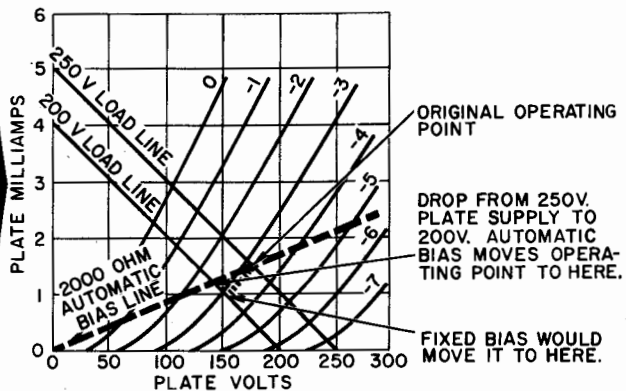

An advantage of this method of biasing is that the bias automatically adjusts to any variations in the circuit. Suppose, for example, that the plate potential drops from 250 volts to 200 volts. If the bias voltage were fixed, this might well over-bias the tube. Using this bias system, however, the shift in load line corresponding with the drop in plate supply voltage produces a new operating point, which will still be optimum. For this reason, this method of biasing is called *automatic* or *self* bias.

GRID BIAS SUPPLY

Self Bias (contd.)

The cathode resistor is not quite all that is needed for providing bias in some instances. Suppose that the plate load resistor is 50,000 ohms and that, with this value of load line, the tube gives a gain of 50. A 1-volt audio signal between grid and cathode will produce 50 volts audio at the plate. The same audio current fluctuation passes through both the plate and the cathode resistors; consequently there will be a proportionate audio voltage at the cathode.

Because the plate resistor is 50,000 ohms and the cathode resistor is 2000 ohms, a 50-volt fluctuation at the plate will be accompanied by a 2-volt fluctuation at the cathode. This fluctuation effectively takes the grid positive from its bias point, increasing plate current, which makes the plate swing negative and the cathode swing positive. Thus a positive fluctuation from grid to cathode will be accompanied by a positive fluctuation from cathode to ground. The total input voltage from grid to ground must be the total of these fluctuations: 1 volt from grid to cathode and 2 volts from cathode to ground, or 3 volts from grid to ground. Thus a 3-volt input is required to produce a 50-volt output and instead of the tube giving a gain of 50, the gain is only about 17. The cathode resistor is providing negative feedback.

To get the full gain of the tube we must avoid this feedback effect. This is accomplished by shunting the cathode resistor by a large-value low-voltage electrolytic capacitor that bypasses the audio voltages. A 50-microfarad capacitor has a reactance of only 63 ohms at 50 cycles and much lower reactances at higher frequencies. With a 1-volt audio input from grid to cathode (at 50 cycles), there will be 50 volts audio output at the plate and about 60 millivolts at the cathode, which is not sufficient to make an appreciable difference in the gain of the stage.

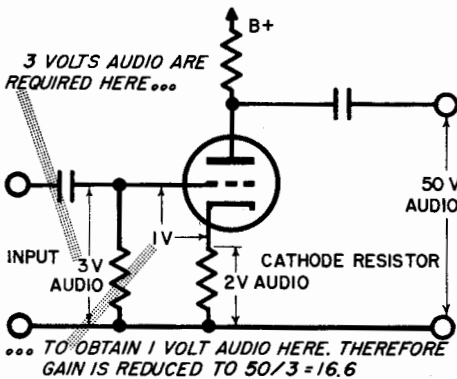

THE CATHODE RESISTOR PROVIDES NEGATIVE FEEDBACK

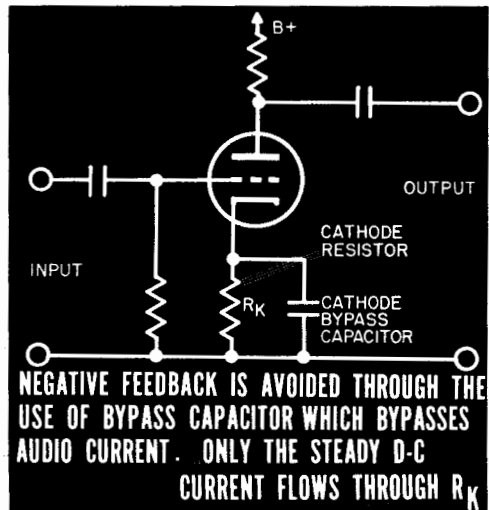

GRID BIAS SUPPLY

Bias in Push-Pull Stages

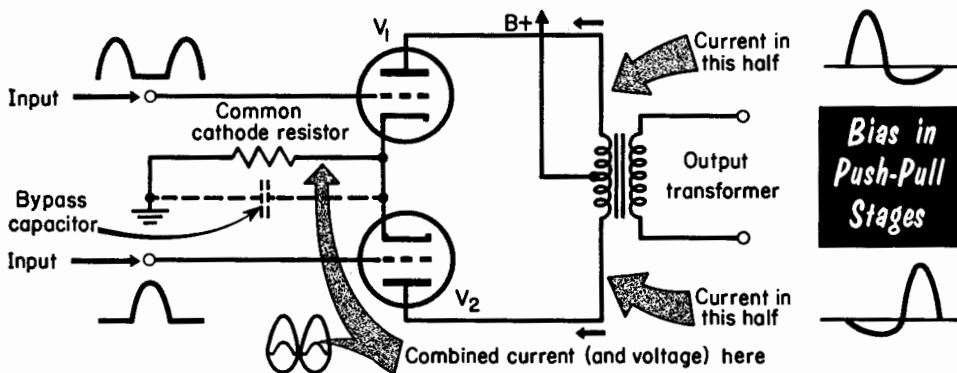

Self bias using a resistor in the cathode circuit is found in push-pull stages as well as in "single-ended" stages. When the push-pull stage is operated class AB, the plate currents in the tubes change appreciably during different parts of the waveform. These currents are added in the common cathode resistor, not subtracted as in the output transformer primary. This results in a double-frequency current in the cathode resistor, because of the asymmetrical current waveforms in the tubes.

The usual operating point of the tubes is arranged so that when no signal is passing, the plate current is appreciably less than the maximum signal-current fluctuation in each direction. This current provides a voltage drop across the cathode resistor that establishes a bias that is quite close to cutoff. When signal current flows, this voltage drop increases, increasing the bias, and reducing the gain of the tube as in a single-ended stage. If a capacitor is connected across the cathode resistor, the fluctuation due to signal currents is smoothed out, resulting in an almost steady bias that is always higher than that present when no signal passes. This means that when the current waveform in the tubes falls toward zero (for which the bias should be at the no-signal level), the higher bias provided by the capacitor may cause premature cutoff and *crossover distortion*.

Bypass Capacitor Affects Bias Voltage

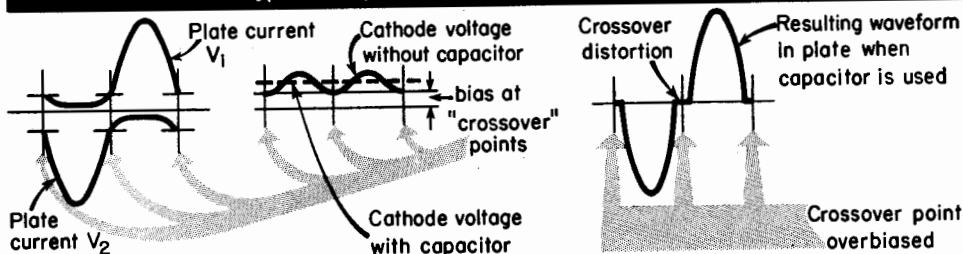

GRID BIAS SUPPLY

Bias in Push-Pull Stages (contd.)

PUSH-PULL STAGE USING AN UNBYPASSED CATHODE RESISTOR

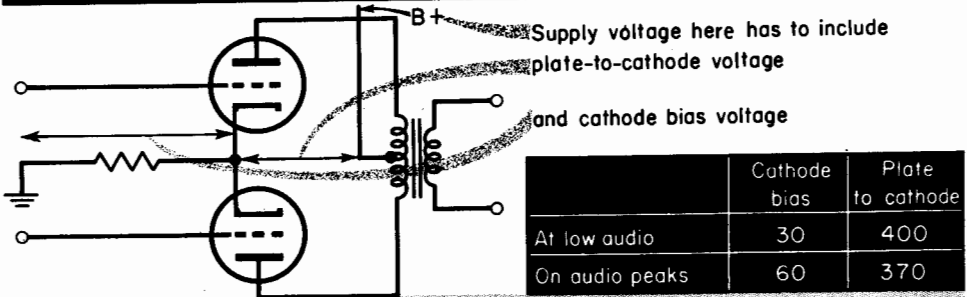

NOTE: This table assumes that B+ does not drop with increased current demand. If it does, reduction in plate-to-cathode voltage on peaks is even worse.

Unfortunately, we cannot solve this problem by using a smaller cathode resistor because it would result in too high a current in the tubes when no signal was passing. The only solution is to omit the decoupling capacitor across the cathode resistor. If we wish to use self bias at all, we must be willing to sacrifice some gain.

A SEPARATE BIAS SUPPLY IS USED TO OBTAIN AN INCREASED OUTPUT FROM THE PUSH-PULL STAGE

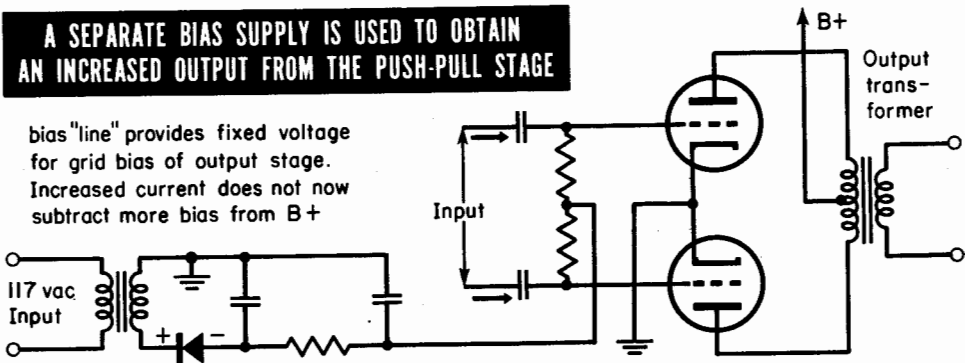

bias "line" provides fixed voltage for grid bias of output stage. Increased current does not now subtract more bias from B+

For this reason, increased output can often be obtained from a push-pull stage by using a separate fixed-voltage bias supply. This supply is usually a simple rectifier that takes an alternating voltage from a suitable point (such as from a voltage divider connected across the high-voltage secondary of the power transformer) and rectifying it with a single diode. A simple resistor-capacitor combination will provide sufficient smoothing because there is no grid *current* requirement. This means the capacitors charge up to the peak alternating voltage, and the resistor merely provides additional filtering to prevent the small leakage current pulses from being passed on to the grid circuits.

SCREEN BIAS SUPPLY

Screen-Biasing Methods

For a pentode tube, a supply is also required for the second (screen) grid. This supply usually has to provide a fixed voltage not greater than the average plate voltage. It would be possible to design a completely separate supply for the screen grid, but because this electrode only requires a small current (a fraction of a milliampere for small tubes of the voltage-amplifying type and a few milliamperes for large output tubes), a separate supply would involve unnecessary expense.

SCREEN-BIASING METHODS

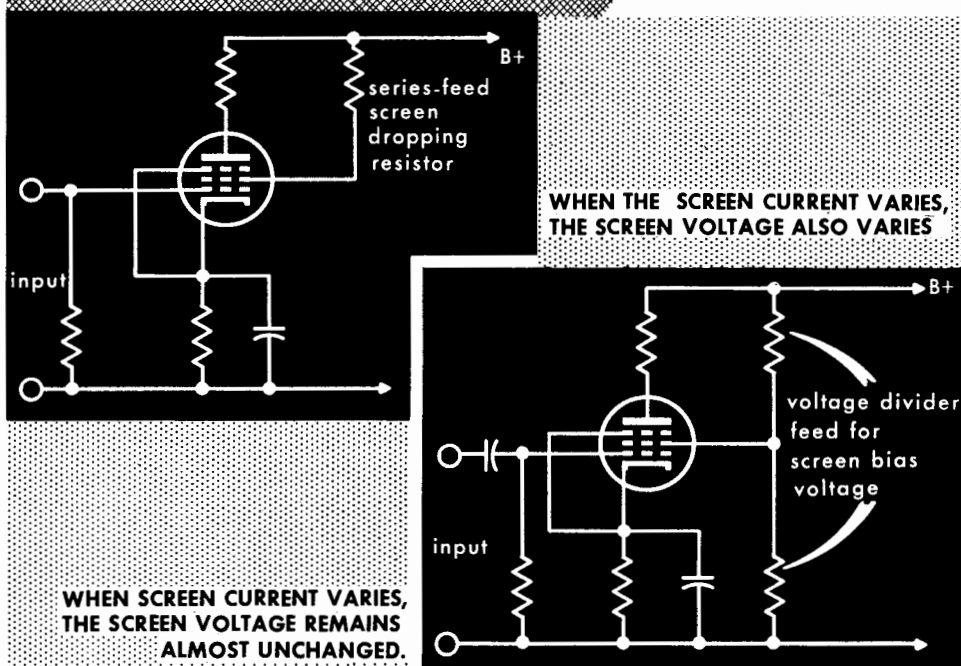

Instead, the screen supply is usually derived from the plate supply, using either a series resistor or a voltage divider. The series-resistor method has the advantage of economy on supply current, because it passes only the current necessary to feed the screen. The disadvantage is that, if the screen current should vary (which it does under certain conditions), the screen potential will also vary, because of the change in voltage drop across the feed resistor. This difficulty may be overcome by using the voltage-divider method (*potentiometer feed*). The two resistors pass a current that is larger than the average screen current and thereby keep the screen potential more steady.

SCREEN BIAS SUPPLY

Potentiometer Feed

Suppose that the supply potential is 250 volts, the average screen current 1 milliampere, and the desired screen potential 100 volts. A single 150,000-ohm resistor would provide the necessary 150-volt drop at this current. If the current rose to 1.2 milliamperes, however, the drop across the resistor would increase to 180 volts, leaving only 70 volts at the screen. If the current should drop to 0.7 milliampere, the resulting drop in the resistor would be only 105 volts, leaving 145 volts at the screen. It is clear that comparatively small changes in screen current result in quite large changes in screen potential, which means that the operating conditions of the tube are not very steady.

If we arrange a voltage divider that draws 5 milliamperes in addition to the screen current, this situation will be improved. The 5-milliampere current from screen to ground will require a resistor of 20,000 ohms to drop the required 100 volts; the 6 milliamperes from the supply to the screen, a difference of 150 volts, will require a resistor of 25,000 ohms. Now an increase in screen current from 1 to 1.2 milliamperes will only change screen potential to about 97.8 volts. If the screen current should drop to 0.7 milliamperes, instead of rising to 145 volts the screen potential will only rise to about 103.3 volts. In this way the extra 5 milliamperes flowing in the voltage divider helps considerably in maintaining a steady screen potential.

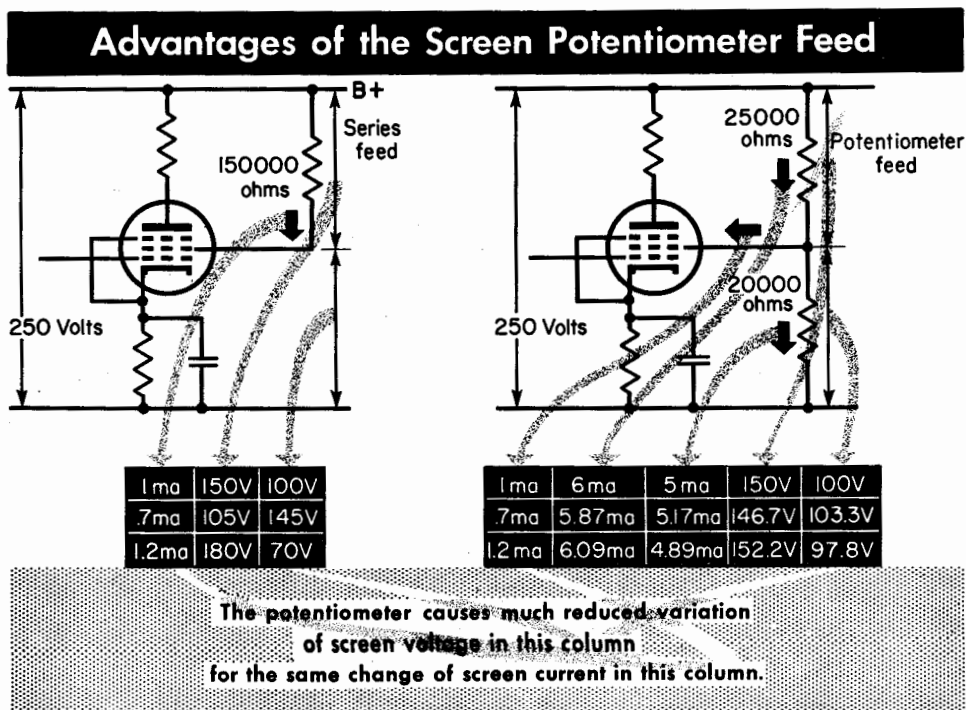

SCREEN BIAS SUPPLY

Maintaining Constant Screen Potential

**AN AUDIO SIGNAL APPLIED TO THE GRID
WILL CAUSE THE SCREEN CURRENT TO VARY**

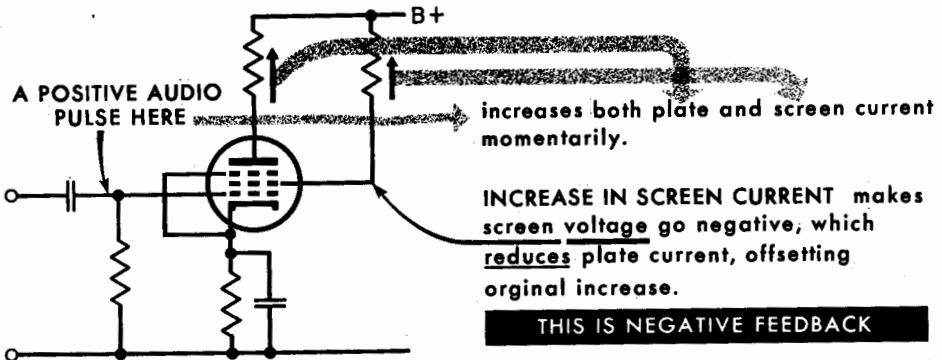

WHEN A CAPACITOR IS CONNECTED BETWEEN SCREEN AND GROUND,

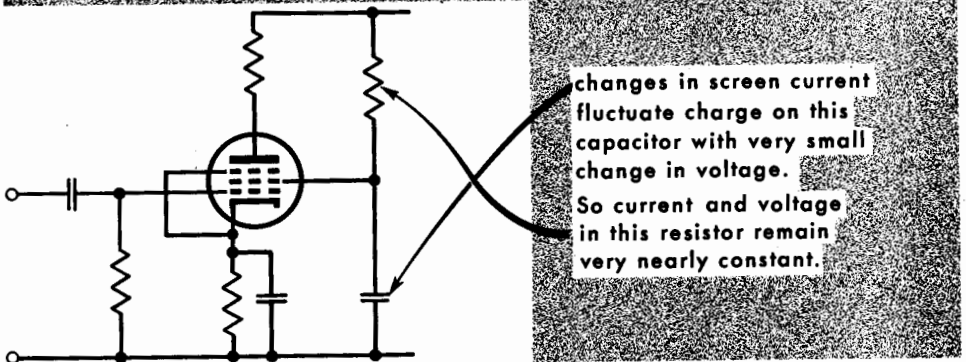

When audio voltages are applied to the grid of a pentode tube, screen current fluctuates as well as the plate current. The screen potential, however, must be held constant if we are to achieve the best operation from the tube, because a constant screen potential enables the plate current and plate voltage fluctuations to be almost independent of each other. If there were only a resistor between the supply voltage and the screen, screen *current* fluctuations would also be accompanied by some screen *voltage* fluctuations, and the plate voltage fluctuation would be affected by the screen voltage fluctuation.

To avoid this, a fairly large capacitor whose charge does not have time to change during the audio fluctuation is connected between the screen and ground. A 0.1-microfarad or smaller capacitor is usually quite large enough for this purpose, because screen current and its fluctuations are small.

FILAMENT OR HEATER SUPPLY

Filament Connections and Voltages

Thus far, we have not discussed how we get electrons into the tube. This requires heating of either filaments or heaters. Most modern tubes employ a cathode with a separate heater. This is a considerable help in the construction of a complete amplifier, because it allows the cathode to be biased to any suitable voltage, while permitting all of the heaters in the different tubes to run from the same supply in any convenient manner.

Usually, with a-c-operated amplifiers, all of the heaters are connected in parallel to a winding on the power transformer. The potential across this winding is chosen to maintain the correct temperature in the tube. This potential is usually 6.3 volts, because this particular voltage happens to coincide with the battery voltage at one time used on almost all automobiles. This heater voltage became standard, because it was then possible to operate the tubes alternately from a battery or a 6.3-volt winding on a transformer.

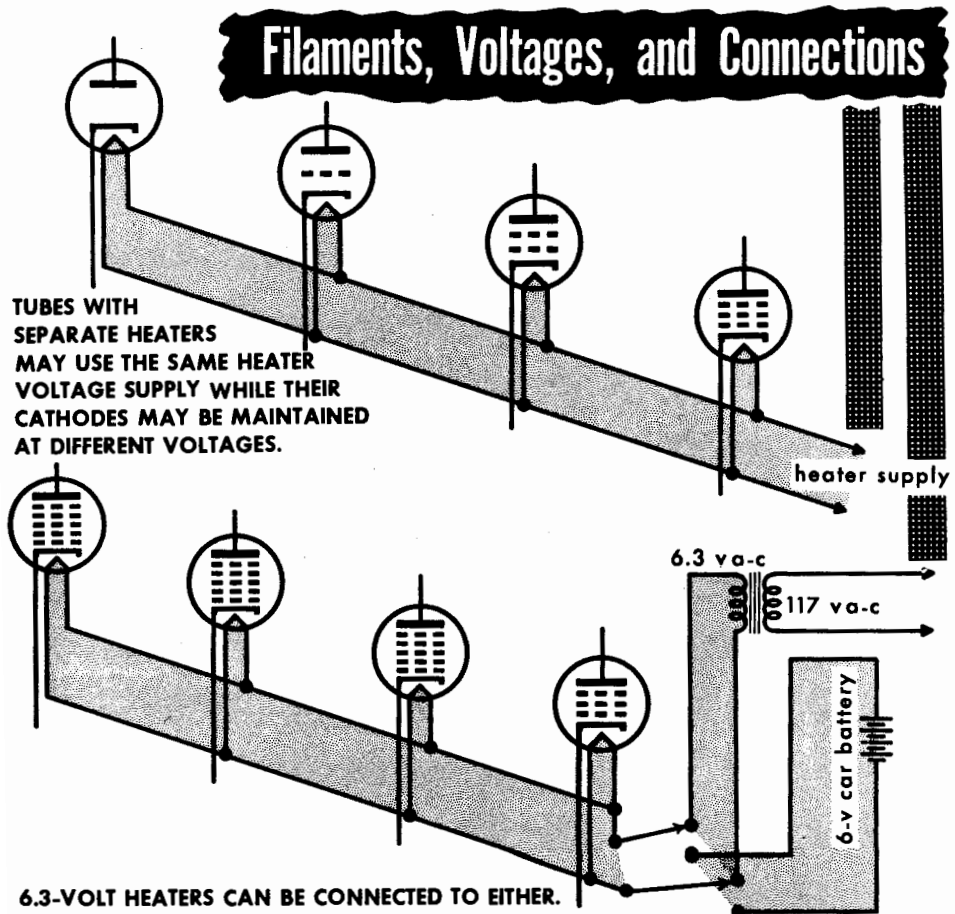

FILAMENT OR HEATER SUPPLY

Eliminating Hum

*Heater may be a source of Hum,
Noise, and Instability*

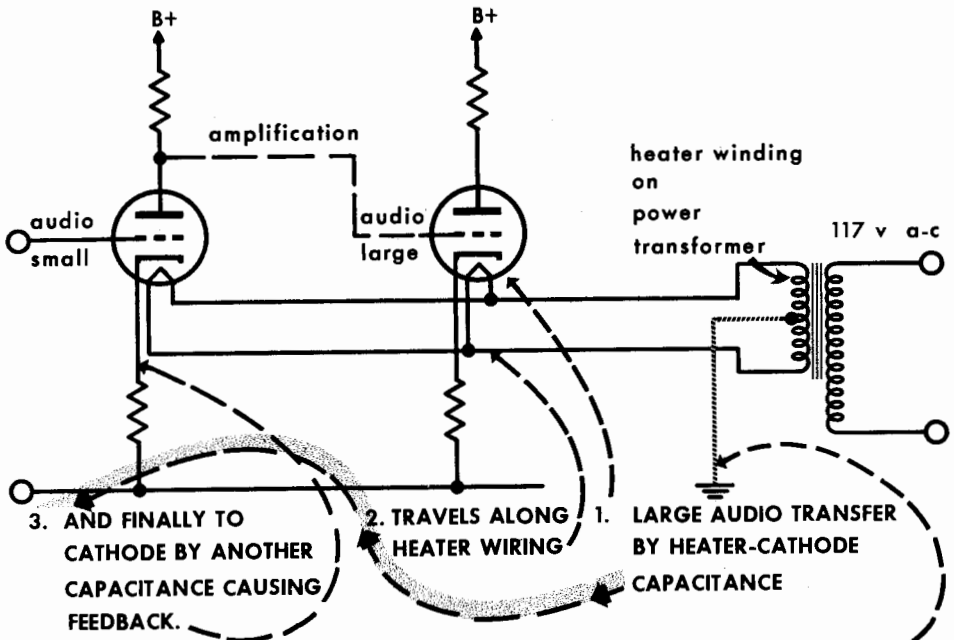

*which can be eliminated by
connecting heater system to ground*

The heaters are a possible source of hum, noise, and instability in the amplifier, particularly at high frequencies. Owing to the capacitance between cathode and heater, audio can be transferred from the cathode in an output tube to the heater wiring and from there to the cathode of the input stage, which would cause oscillation. The remedy for these troubles is to connect the heater wiring to a ground point, so that any capacitive transfer from the output-stage cathode to the heater wiring is immediately conducted to ground. Then, although minute currents may flow between the cathode and heater wiring, there will be no *audio* voltage corresponding to them.

TRANSFORMERLESS POWER SUPPLY

Eliminating the Power Transformer

Another system of supply was developed for use where the power source might be either a-c or d-c. (There are parts of the country where d-c power is still provided.) This method has the advantage that a power transformer is not required, which results in some saving in cost. (For this reason, similar circuits are also applied where there is no intention of using the equipment on d-c. In this arrangement, the heaters are wired in series. The tubes are designed to take the same heater *current* instead of the same heater voltage. (Typical heater *current* lines operate at 0.1 ampere or 0.15 ampere.) If the total voltage drop across all of the heaters in series adds up to, say, 84 volts, a series resistor will be used to give the required 117-volt drop total.

HEATERS ARE CONNECTED IN SERIES

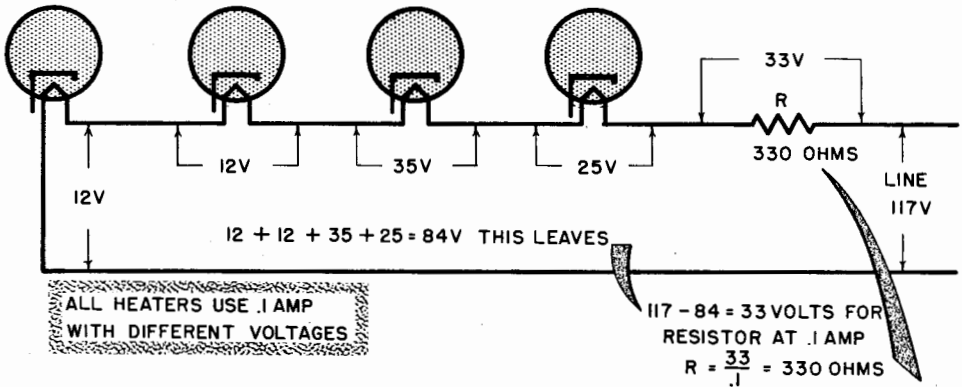

In this case, the plate supply is usually half-wave rectified, using very large capacitors to keep the voltage up. In addition, special tubes are used that operate satisfactorily at relatively low plate voltages, such as 150 volts.

PLATE SUPPLY MAY USE LARGE CAPACITORS TO KEEP THE VOLTAGE UP

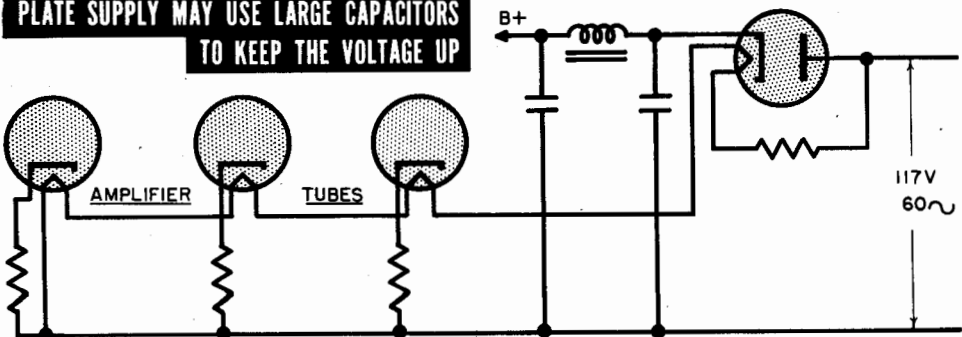

TRANSFORMERLESS POWER SUPPLY

Ground Problems

A special ground connection is needed to make transformerless equipment safe. The supply-circuit "ground" is connected to one side of the supply, which may be the "live" side, if the power plug is not put in the right way around. This is a hazard because metal parts of the amplifier become capable of giving shocks. For this reason, two ground points must be provided. The circuit ground is wired so that it is not accessible at any point. A very small capacitor is connected between this high-voltage negative line and the metal parts that are accessible and thus liable to be touched. (This capacitor has to have a very high breakdown rating if the metal parts are to remain isolated from the line voltage.) The use of this capacitor insures the user that touching a metal part of the amplifier can give him only a slight tingle, (due to the microscopic currents that pass through the capacitor). To avoid introducing hum, the chassis has to be carefully arranged so that any accessible metal parts are not close to the low-level audio wiring.

This means the chassis construction must be double. All of the amplifier circuit is arranged to be within a chassis that is connected to supply negative, while a second chassis, insulated from the first, encloses it, eliminating the risk of shock.

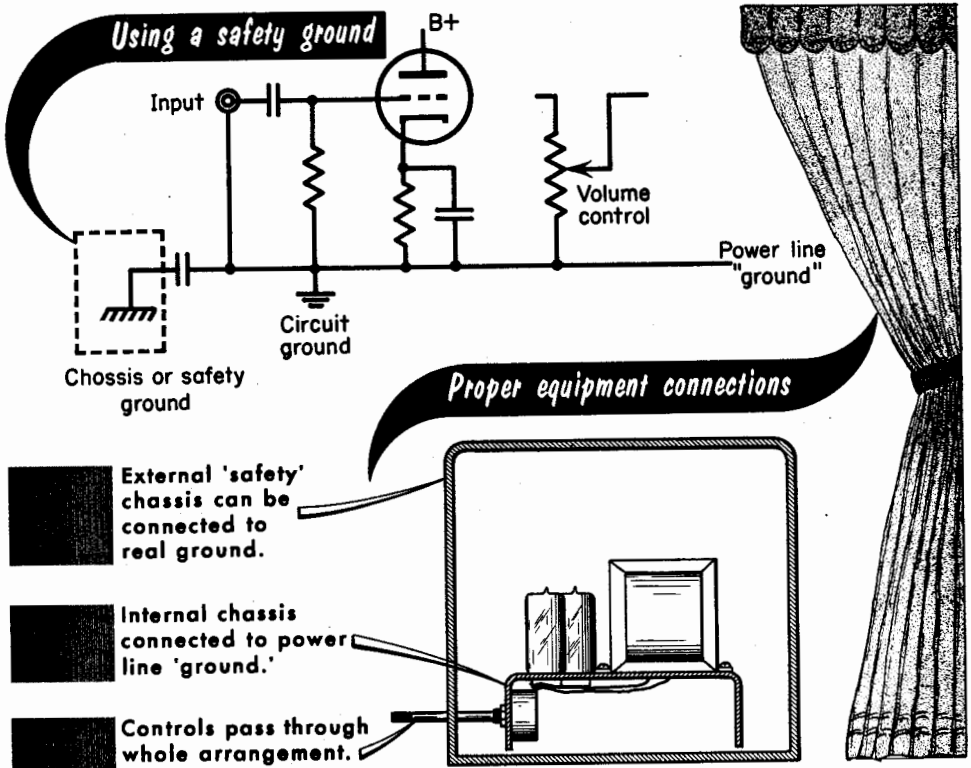

QUESTIONS AND PROBLEMS

1. Why is an a-c power supply more convenient for many purposes than a d-c? What kinds of rectifier can be used for converting a-c to d-c for operating tubes or transistors?
2. Explain how (a) a choke and (b) a capacitor may be used to smooth out the large fluctuations in rectified a-c.
3. Distinguish between the inherent characteristics of smoothing filters utilizing (a) capacitor input and (b) choke input. Also, show how a "swinging choke" combines features of both and for what purpose.
4. Additional filtering is often provided for various supply points in an amplifier, but is usually called "decoupling." Explain the significance of this term.
5. Distinguish between self or automatic bias and fixed bias for tube operation. In what way is the former automatic?
6. Why should a bypass capacitor be used with an automatic bias circuit? Under what circumstances does automatic bias work better without this bypass, and why?
7. What is crossover distortion, and what causes it? How can it be avoided?
8. What two methods of supplying screens are used? If a screen is to be operated at 150 volts from a 250-volt supply, what resistors should be used so that change of screen current from 0.5 milliamperes to 1.5 milliamperes only changes the voltage from 155 to 145 volts?
9. Why is a capacitor necessary with a screen supply circuit? Explain why a cathode bypass capacitor may be as much as 50 microfarads or more, while a screen capacitor can be only about 0.1 microfarad.
10. What two principal methods of connection are used for tube heaters?
11. For what reasons may equipment be designed to work without a transformer in the power supply? What particular precautions are necessary in this kind of equipment?
12. What remedies would you try if an amplifier or other piece of audio equipment developed hum?

SHIELDING

The Need for Shielding

One of the problems of audio amplifiers is the fact that audio voltages and currents are often so small that the circuits carrying them have to be protected against unwanted voltages and currents induced from other circuits. There are three kinds of unwanted induction: power, crosstalk, and feedback.

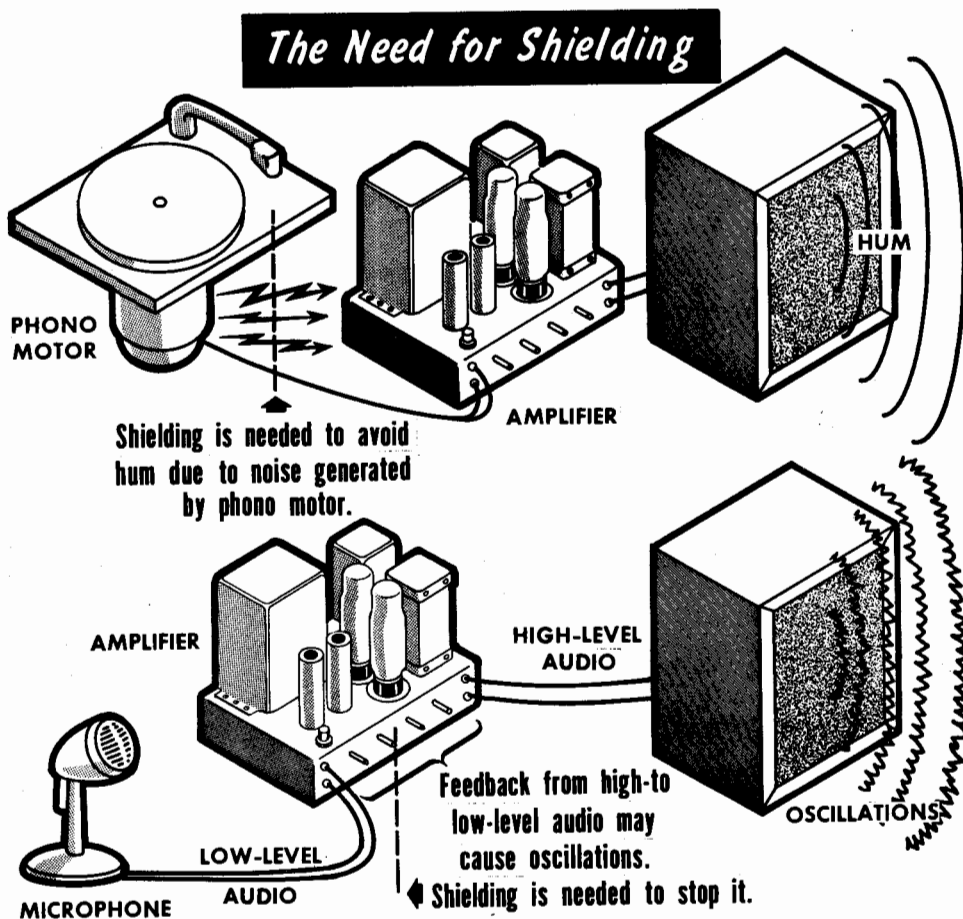

All kinds of power components and circuits radiate at power frequencies (mostly 60 and 120 cycles). If this radiation is induced into a low-level audio circuit, hum will result. The second kind of induction is that of high-level circuit, if the two are in close proximity to each other. (This interference is known as *crosstalk*.) If the *same* audio at high level is induced in low-level circuit, it is the same as undesired feedback, which can cause instability or oscillation.

SHIELDING

The Need for Shielding (contd.)

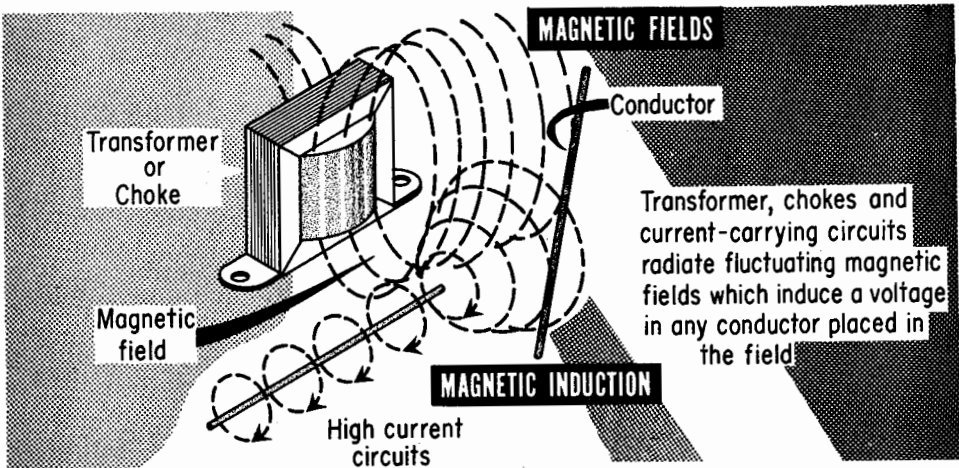

The solution for all of these troubles is shielding to protect the low-level circuit against pickup due to magnetic or electric fields. Any transformer will radiate some *magnetic* field. Audio transformers radiate a magnetic field that contains audio, and power transformers radiate at power frequencies. (Chokes can also radiate at these frequencies.) These magnetic fields can induce voltage in low-level circuits by magnetic induction. This works by causing a voltage to be induced (in the same way that a transfer of energy occurs in a transformer) whenever the field changes or fluctuates. An electric field is caused by the presence of high voltages. Any high-level circuit carrying high audio or power voltages will radiate an electric field that can induce charges in a low-level audio circuit, producing pickup.

Point of high-level electric potential

ELECTRIC INDUCTION

Low-level point in field picks up some of the potential

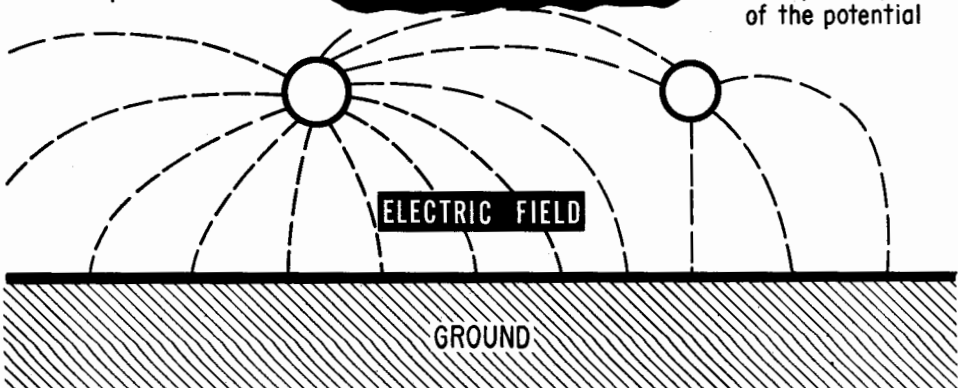

SHIELDING

The Effect of Circuit Impedance

WITHOUT SHIELDING, MAGNETIC INDUCTION IS MORE TROUBLESOME IN LOW-IMPEDANCE THAN IN HIGH-IMPEDANCE CIRCUITS

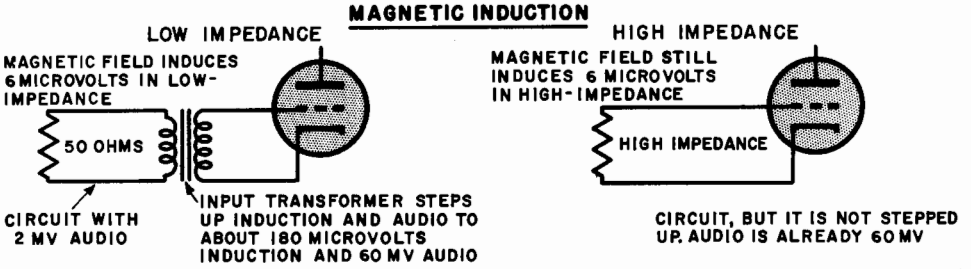

Without the use of shielding, magnetic induction is usually more troublesome to low-impedance circuits than to high-impedance circuits, because a magnetic field will induce the same voltage in a loop regardless of its impedance. Suppose that the magnetic field induces 6 microvolts in a given circuit loop. If the circuit has a high-impedance, the audio voltage level may be 60 millivolts, which gives a margin of 80 db (a voltage ratio of 10,000:1). If the circuit has an impedance of only 50 ohms, however, the audio is likely to be about 2 millivolts. A transformer with a step-up ratio of 30:1 (an impedance ratio of almost 1000:1) could step up this voltage to the same 60 millivolts as that in the high-impedance circuit. As well as stepping up the 2 millivolts of audio, however, the transformer would step up the undesired 6 microvolts to about 180 microvolts. Hence, *with the same magnetic field*, the high-impedance circuit gives a margin of 80 db (10,000:1), while the low-impedance circuit only gives a margin of 50 db. (312:1).

The opposite is true with electric induction. If the surface on which charge is induced by a nearby voltage has a high-impedance connection to ground, the charges will not have time to leak away and voltages will appear with them, causing interference. If, on the other hand, the surface is connected by a low-resistance path to ground, the charges will leak away rapidly without causing this interference. This means that low-impedance circuits are less susceptible to electric induction than high-impedance circuits.

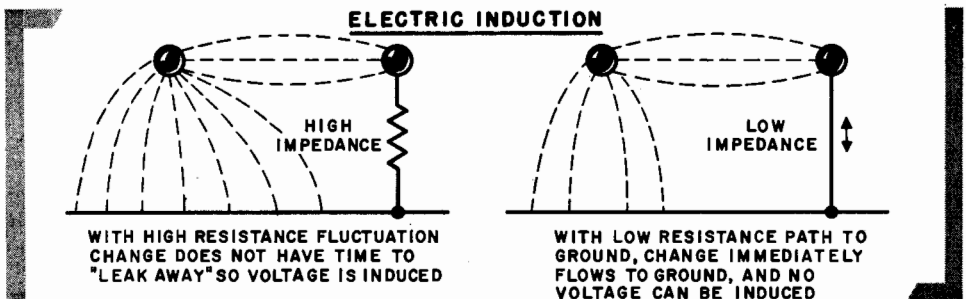

SHIELDING

Magnetic Shielding

There are three kinds of shielding: magnetic, electromagnetic, and electric. Magnetic shielding prevents the magnetic field that causes the induction from reaching the low-level circuit. The entire circuit or transformer is surrounded by the shield. The inducing field passes into the shield, around the circuit to be shielded and out at the other side. This reduces the induction inside the shield by a factor dependent upon the *permeability* of the magnetic material of which the shield is made, the thickness of this material that provides a magnetic conducting path, and the frequency of the magnetic fluctuation.

Magnetic Shielding

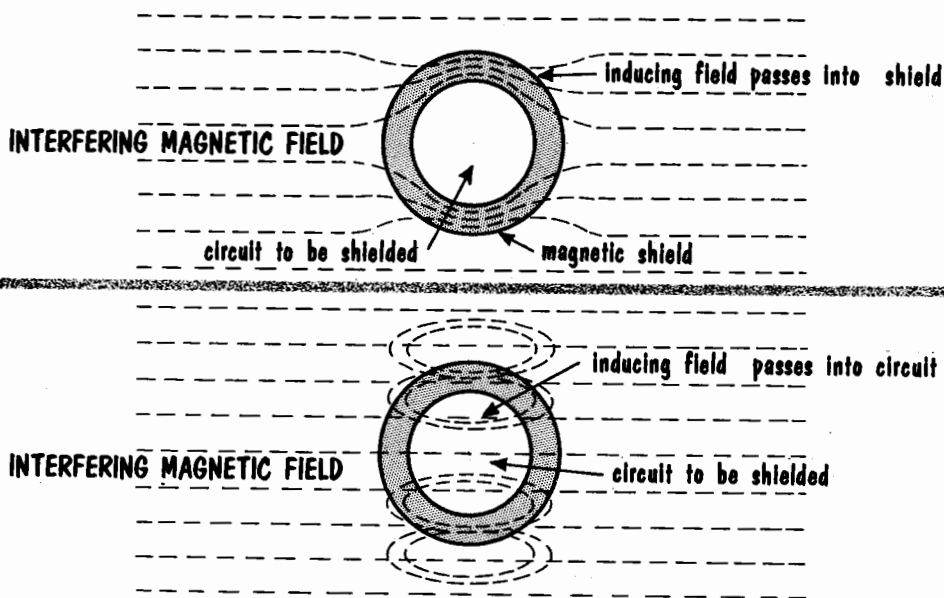

AT HIGHER FREQUENCIES, FIELD CHANGES TOO FAST FOR SHIELD TO WORK. SHIELD PRODUCES DELAYED REACTIONARY FIELD, WHICH DOES NOT ELIMINATE INDUCTION ANY MORE.

Magnetic shielding is most effective against steady magnetic fields and low-frequency induction, such as hum. At higher frequencies, it becomes less and less effective because the magnetism takes time to be induced in the material of the shield. The faster the inducing magnetic field fluctuates, the less effective the shield is in conveying the magnetic field around the shielded circuit.

SHIELDING

Electromagnetic Shielding

The second type of shielding uses a different principle, but is also effective against magnetic fields. Electromagnetic shielding does not use a magnetic material, but rather one that conducts electric current well, such as copper or aluminum. When the magnetic field causing the induction fluctuates, it causes current to flow in the shield. This current in the shield sets up its own magnetic field that opposes the original inducing magnetism, and the two fields tend to cancel inside the shield.

Electromagnetic Shielding

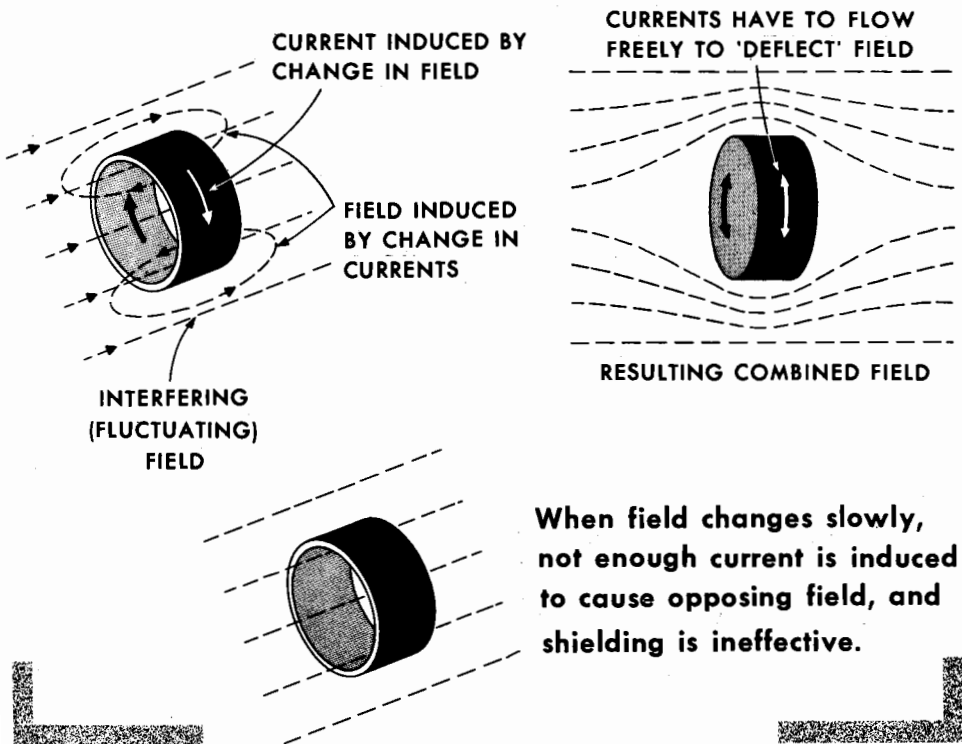

Outside the shield, the two fields are in the same direction and the combined magnetic field is increased. Therefore, this kind of shield has the effect of "pushing" the inducing field outward, instead of permitting it to reach the shielded circuits. Because it depends on fluctuating fields, this kind of shield is completely ineffective against steady magnetism. It is also comparatively ineffective against low-frequency fluctuation, and only becomes really effective at higher frequencies.

SHIELDING

Electromagnetic Shielding (contd.)

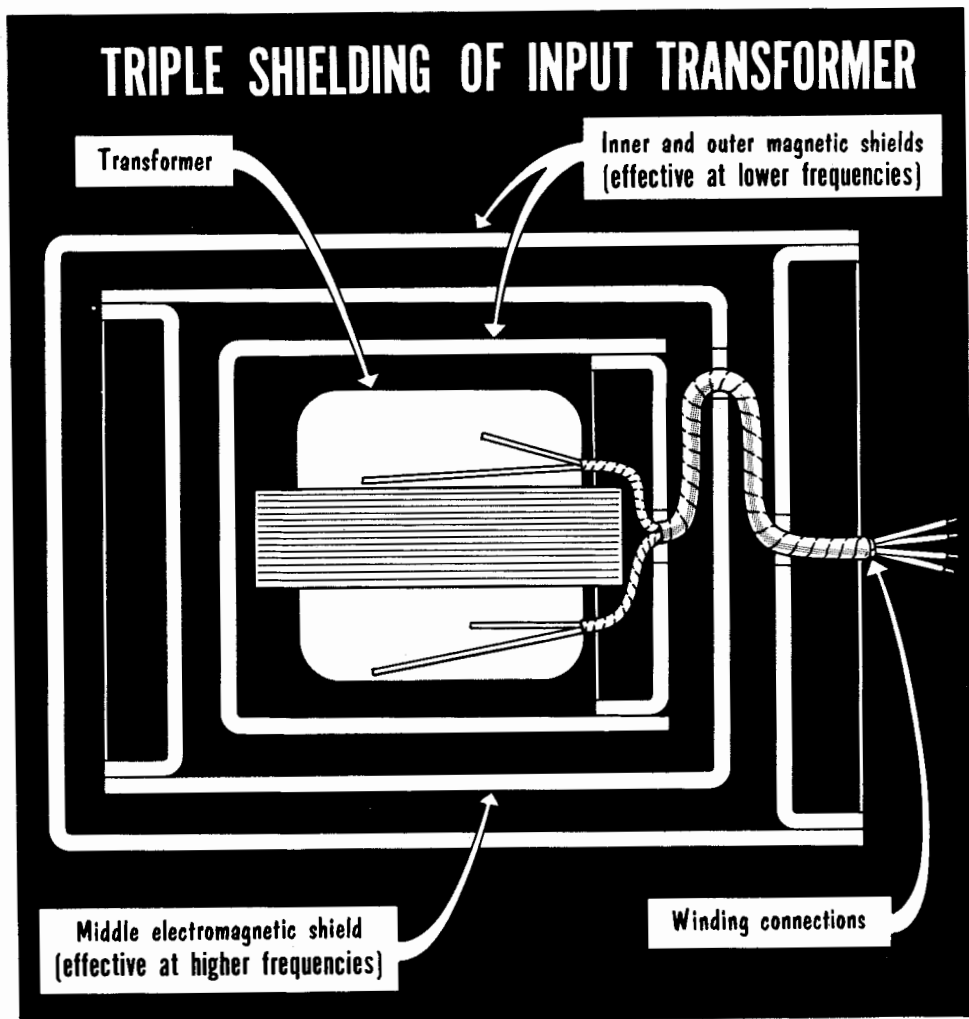

With input transformers, which are particularly susceptible to magnetic fields because they have a magnetic core, the shielding often consists of an arrangement combining magnetic and electromagnetic shielding into one composite assembly. As well as providing increased protection, the combination makes the arrangement more effective over the entire frequency range. The magnetic shielding takes care of frequencies down to zero or d-c and begins to become ineffective at frequencies between 60 to 300 cycles. The electromagnetic shield, on the other hand, begins to become effective between 60 and 300 cycles, and the combined protection is effective for all frequencies.

SHIELDING

Electric Shielding

The third kind of shielding is a protection against electric induction, commonly called *electrostatic* induction. (*Electrostatic* induction is really a misnomer; this induction is better called *electric* induction, because it depends upon the continuous fluctuation of the charges induced.)

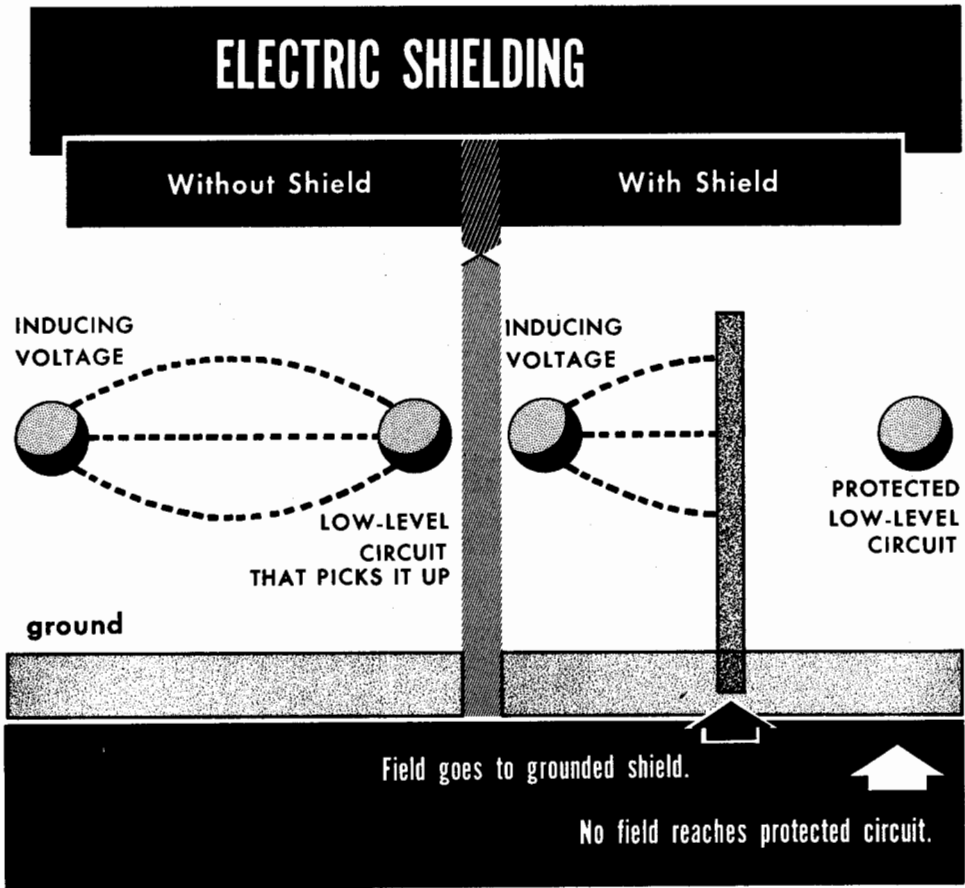

Electric shielding consists of interposing a grounded shield between the interfering voltage and the low-level circuit that might pick up the electric field. The voltage induced is immediately carried off to ground, and the electric field is prevented from reaching the circuit that is shielded. Unlike either form of protection against magnetic fields, shielding against electric fields can be almost 100% effective. All that is necessary is to insure that no path is left through which the electric field can pass. For this reason, much more attention is given to the prevention of induction by *magnetic* fields.

AUDIO TRANSMISSION LINES

Coaxial Lines

Sometimes a connection of considerable length will be required between a microphone and its amplifier. Because the signal is at a very low level, we have to take precautions against possible unwanted pickup due to induction from magnetic or electric fields. In addition, we must transfer to the amplifier as much as possible of the audio voltage picked up by the microphone, to maintain the signal well above the noise level.

As a protection against electric pickup, a high-impedance connection starting from a 50,000-ohm or higher-impedance microphone would have to use a concentric or coaxial arrangement of the wires. The outside conductor (sleeve) would be connected to ground, so that any electric field reaching it would be conducted along this outer sleeve and go to ground at the amplifier without inducing any voltage on the inside wire. This effectively protects against electric pickup.

This type of line also protects against magnetic pickup, because any magnetic field will induce exactly the same voltages in both the inside wire and the outer sleeve. As the complete circuit from ground to the live side of the input *at the amplifier* consists of the entire line out to the microphone and back, the total voltage induced by the magnetic field will cancel out giving zero resultant induction.

Shielding a Line against Electric and Magnetic Fields

Outer sheath conducts electric induced charges to ground.

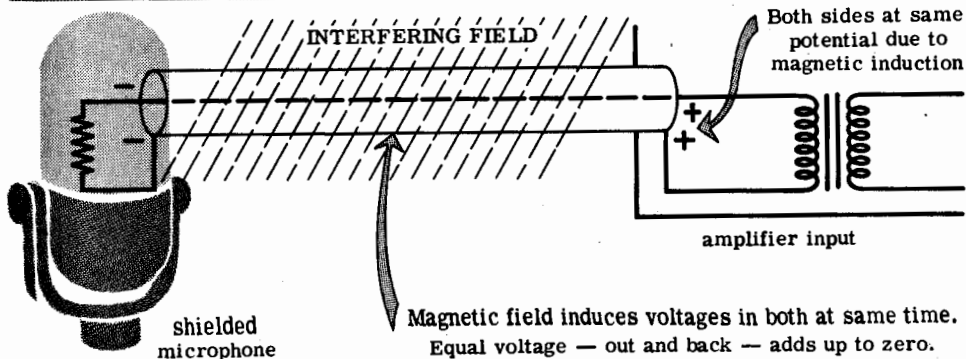
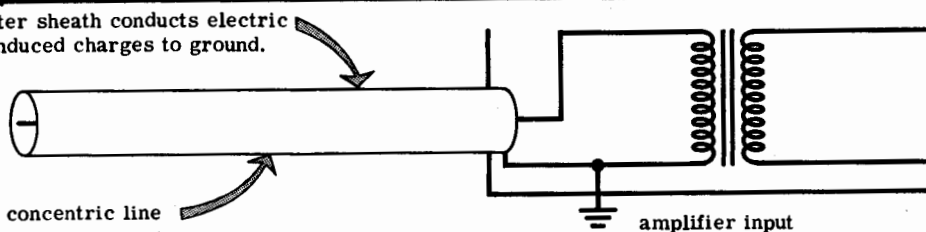

AUDIO TRANSMISSION LINES

Coaxial Lines (contd.)

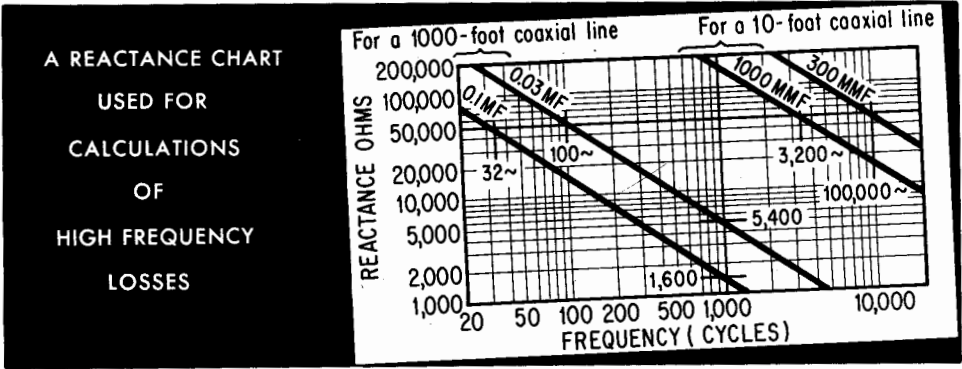

The reason why this type of line is not satisfactory is that the capacitance between the center wire and the sleeve is very considerable — usually between 30 and 100 micromicrofarads per foot. (This capacitance shunts the source and load impedances between which the line is usually connected.) A 1000-foot length of coaxial line will have a capacitance of 30,000 to 100,000 micromicrofarads, which on a 50,000 ohm circuit would have a reactance equal to the source impedance at a frequency between 32 and 100 cycles. This would cut the signal voltage fed to the lead by 70% (3 db). At 1000 cycles, the reactance would be about 1600 to 5400 ohms, resulting in a loss of 20 or 30 db, and the loss gets progressively more severe with higher frequencies. Even a 10-foot length of coaxial line, with a capacitance of from 300 to 1000 micromicrofarads, will have a reactance of 50,000 ohms at from 3200 to 10,000 cycles, which will cause an appreciable loss of signal at frequencies above this point.

Low-impedance circuits, as already mentioned, are more susceptible to the pickup of magnetic fields than electric fields. Use of a concentric line helps to shield them, and a twisted line improves matters by making the field induce voltages opposite directions in successive twists. The twisted line may also be shielded by a separate ground sleeve to minimize any electric pickup.

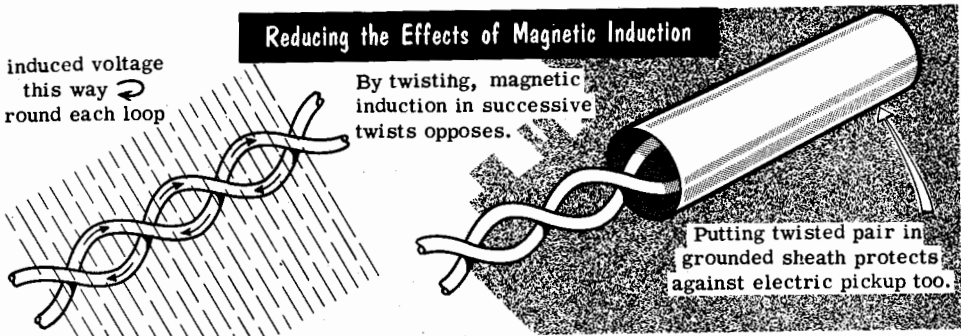

AUDIO TRANSMISSION LINES

Low-Impedance Connection

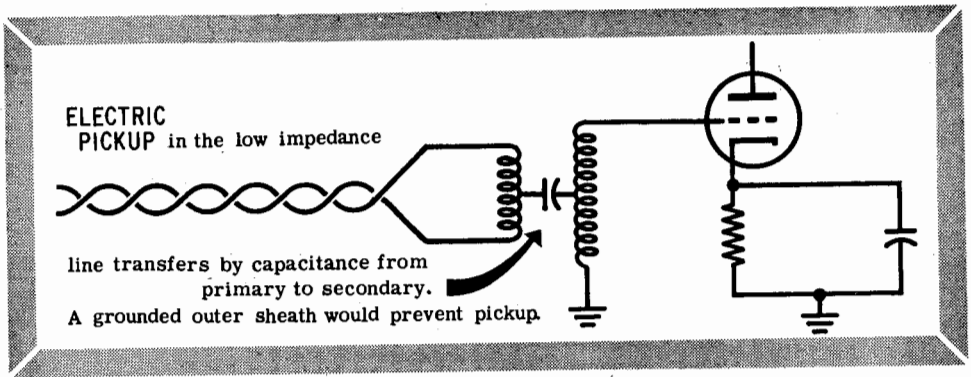

Although electric pickup is not important to the low-impedance circuit itself, it *can* be transferred from the primary to the secondary of the transformer by the capacitance between windings. Use of an outside sheath as an electric shield will help prevent this.

The principal problem with a low-impedance (50-ohm or lower) line for long-distance connection is the resistance of the wire itself. Unless a very heavy gage is used, the line will have a resistance of about one ohm for every 50 feet. (A 5000-foot length would have a resistance of 100 ohms.)

RESISTANCE LOSSES DETERIORATE PERFORMANCE

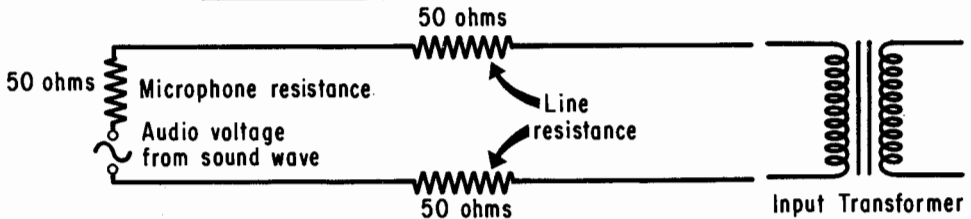

1. If input transformer primary is for 150 ohms, step-up will be 5 db less than for 50 ohms.
2. If input transformer primary is for 50 ohms, frequency response will be seriously depleted.

If the microphone impedance is 50 ohms and the resistance of the connecting wire is 100 ohms, the total input resistance to the amplifier will be 150 ohms. This means the input transformer can step up only from 150 ohms instead of from 50 ohms, as it could if the line were quite short. If all of this 150-ohm impedance were due to the microphone itself, the microphone would produce a correspondingly higher audio voltage; however, this is not the case. What we actually have is a 150-ohm source providing only the audio voltage that would be provided by a 50-ohm source.

AUDIO TRANSMISSION LINES

Line Impedance

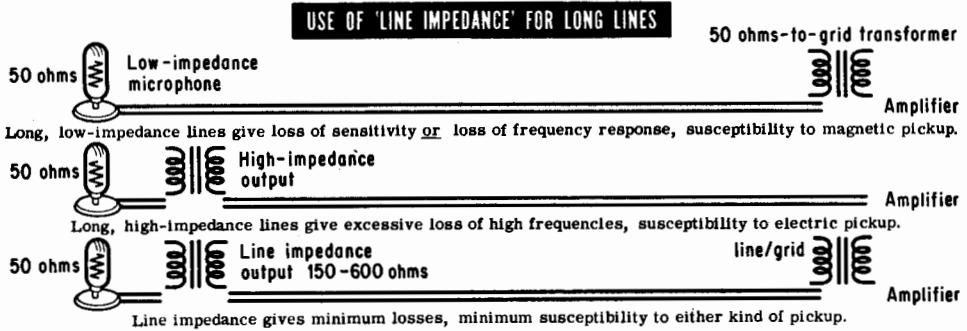

There is clearly a disadvantage to both high and low impedance for running long lines. For this reason, an intermediate impedance, in the region of 500 or 600 ohms, is usually chosen for making long-distance connections. It minimizes the possible effect of magnetic and electric induction, and avoids high-frequency losses that occur at high impedance and the *attenuation* due to line resistance that occurs in using low impedance. In input circuits, for example, a transformer is used so that the impedance of the microphone or pickup looks like 500 or 600 ohms at the transformer secondary. The amplifier has an input transformer that works correctly with a 500- or 600-ohm source. The impedance measured across the line between the two transformers is 500 or 600 ohms, and the line is said to work at an impedance of 500 or 600 ohms. Similar techniques are used with high-level output circuits as well. The impedance at which a line is being used is a characteristic of its termination, not of the line itself.

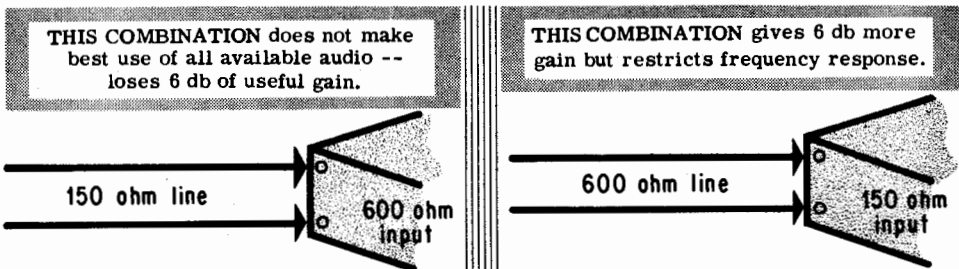

There is nothing particularly magical about one particular line impedance. The use of any middle-value impedance (150, 250, 500, or 600 ohms) merely minimizes the defects of either high or low impedances. It is, of course, good to use a consistent impedance in any particular system. Using a 150-ohm impedance and connecting it to a transformer designed for a 600-ohm impedance at the amplifier (or vice versa) will not make the best use of the available audio.

TRANSIENT EFFECTS

Ringing

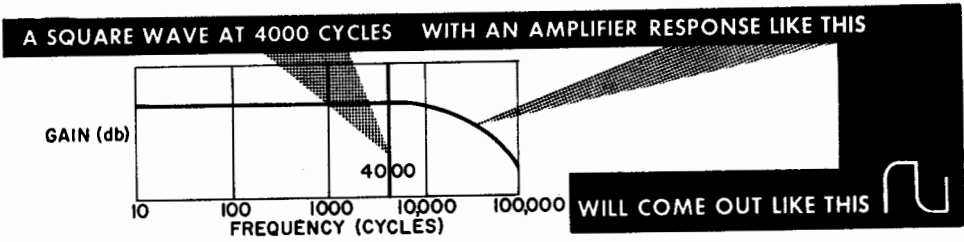

In Volume II, we briefly discussed the problem of *transient distortion*. The usual cause of distortion to square waves is the way in which amplification varies at high frequencies. If the amplifier's frequency response rolls off slowly, the corners of the square wave will be rounded. If, however, the response is uniform up to the highest frequency in which we are interested, say 10,000 or 20,000 cycles, and then at some frequency *after that* rises up to a peak, *ringing* occurs. The sudden shock given by the corner of a square wave excites this peak or resonance in the frequency response and the square wave loses its square corner, developing an oscillatory waveform every time this arrives.

It is not necessary to have a detectable peak at the high-frequency end of the response to get a similar effect. If the range of frequencies over which uniform response is maintained is extended by offsetting the high-frequency loss by peaking, the overall response curve appears quite flat, and then drops off sharply, without showing a peak. The fact that a peaking circuit has been used to extend the response produces the same effect as a peaked overall response curve — every time the corner of the square wave hits it, ringing results. For this reason, an amplifier with a sharp rolloff also produces ringing on square waves. This is true whether the sharp rolloff is produced by this kind of synthesis or, even more important, by feedback adjustments.

Ringing can cause other troubles in an amplifier in addition to unwanted oscillation on the corners of a square wave. For example, the oscillation may cause grid current to flow, when otherwise the amplifier would be well within its safe limit, and this, in turn, can initiate other troubles.

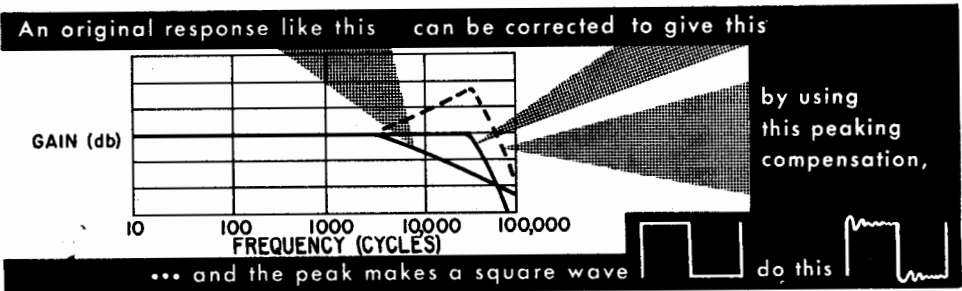

TRANSIENT EFFECTS

Bounce

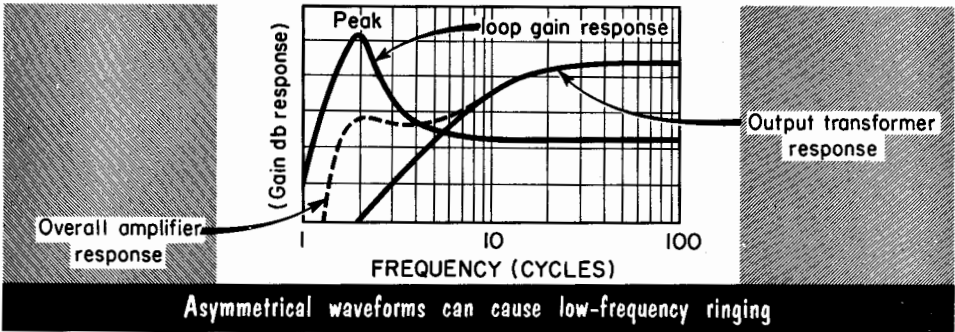

Another variation of transient distortion occurs with feedback amplifiers. The low-frequency stability, as shown in the Nyquist diagram, may not have sufficient margin. This may not result in oscillation at the low frequency, but gives a peak in the *loop gain* response ($A\beta$) at a low frequency, such as 1 or 2 cycles. This peak may not show in the *overall* response of the amplifier, because the output transformer may produce sufficient loss to offset it. Nevertheless, asymmetrical waveforms (which have the effect of a sudden application of d-c) can cause this peak to give a low-frequency ringing (*bounce*) of 1 or 2 cycles per second. The bounce itself may not appear in the output, but it can result in quite serious intermodulation because some stages will not amplify uniformly at different parts of this high-amplitude very-low-frequency waveform.

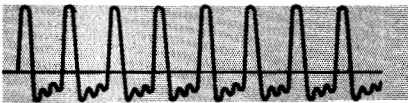

asymmetrical wave before amplification

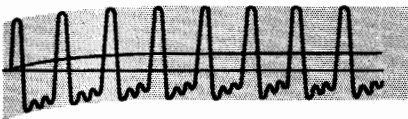

normal way bias readjusts for asymmetry

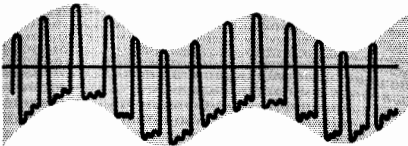

'bounce' due to low-frequency feedback ringing

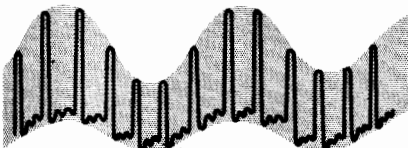

form of distortion caused by 'bounce'

TRANSIENT EFFECTS

Due to Power Supply

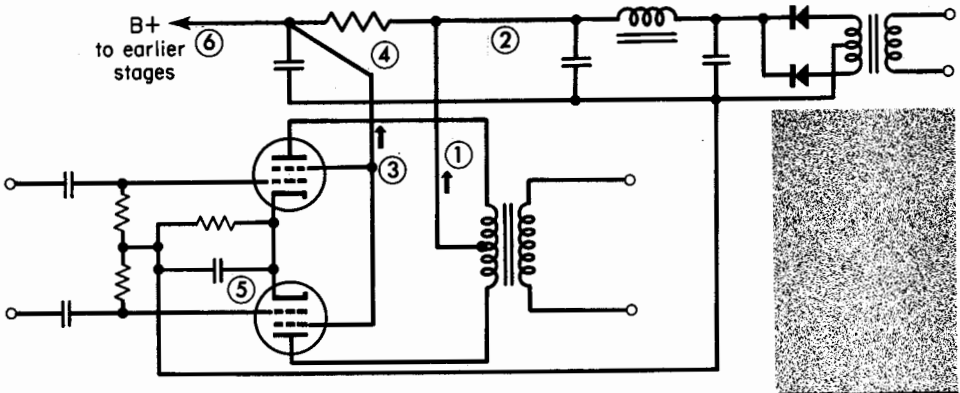

Sudden changes of audio level in Output Stage cause

- | | |
|---|---|
| <p>① plate current rises</p> <p>② plate voltage drops</p> <p>③ screen current rises</p> | <p>④ screen voltage drops</p> <p>⑤ bias voltage increases</p> <p>⑥ supply voltage to earlier stages drops</p> |
|---|---|

When audio level rises.



INPUT WAVEFORM

OUTPUT WAVEFORMS

Two Kinds of Distortion Caused by Delayed Changes Voltage

The effect of a transient on the power supply may result in one type of transient distortion. A sudden burst of audio usually causes the current demand from the high-voltage supply to change, and with it the grid bias for the output stage and possibly the voltage supplied to the screens of any pentode tubes. This change takes time. When the change in audio is suddenly applied to the amplifier (as might happen when amplifying piano notes, for example), all the operating voltages and currents in the tubes are at their condition for minimum audio. When audio arrives at a high level, the amplifier starts to handle it, with the operating voltages and current as a moment before, but the current increases rapidly and the voltages begin to change. This change sometimes alters what happens in the amplifier and can introduce some kind of distortion before the amplifier gets to its new condition. The gain might also be altered in such a way that the quality of the applied transient (the piano note, or whatever it may be) is changed considerably.

THE AUDIO AMPLIFIER

The Complete Amplifier

The complete audio amplifier requires a lot of "putting together." From the designer's viewpoint, first is needed a power output stage to deliver whatever power is required, with satisfactory performance. To make this work, it has two requirements: adequate audio input to control it and the various power supplies to operate the tubes or transistors. If the current or voltage requirement of the output circuit varies according to the audio input level, the power supply circuit must accommodate this variation properly, without changing the voltage or current more than can be permitted.

To get the audio input, voltage or current amplification (according to whether you use tubes or transistors) is needed so that the small input from a pickup or microphone delivers enough to drive the power stage. Then feedback will be added to get the best possible performance from this combination. In considering feedback, do not forget that supplying the different stages from a common power supply can result in output circuit audio fluctuations being fed back to input stages, which are more sensitive. This can cause instability if not properly controlled.

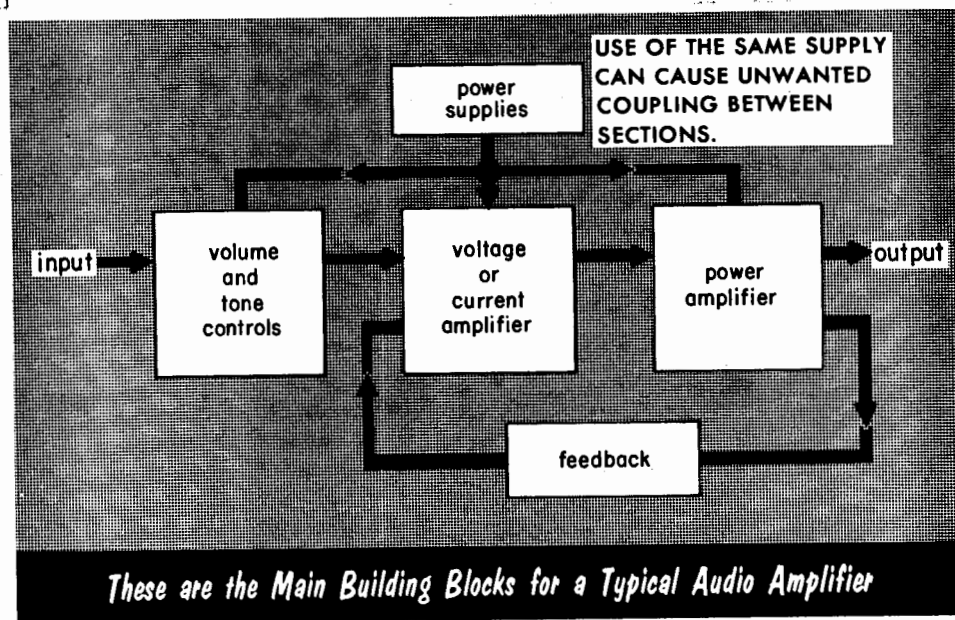

Finally, you need certain controls, volume, and tone, as well as equalization. These have to be put outside the main feedback loop, although they may use some feedback of their own. But if you make the mistake of putting feedback around a volume or tone control, the feedback will carefully undo all the effect of the control! It holds the gain steady, and has no means of knowing that you *meant* it to change.

AUDIO OSCILLATORS

L-C Oscillators

As well as amplifiers, to make audio waveforms larger, we also need oscillators to produce audio waveforms. They may be needed for testing, for electronic musical instruments, or for the high-frequency bias and erase in tape recording. In addition, they supply control frequencies needed for some kinds of automatic operation. In audio work, the exact waveform of the oscillation is important.

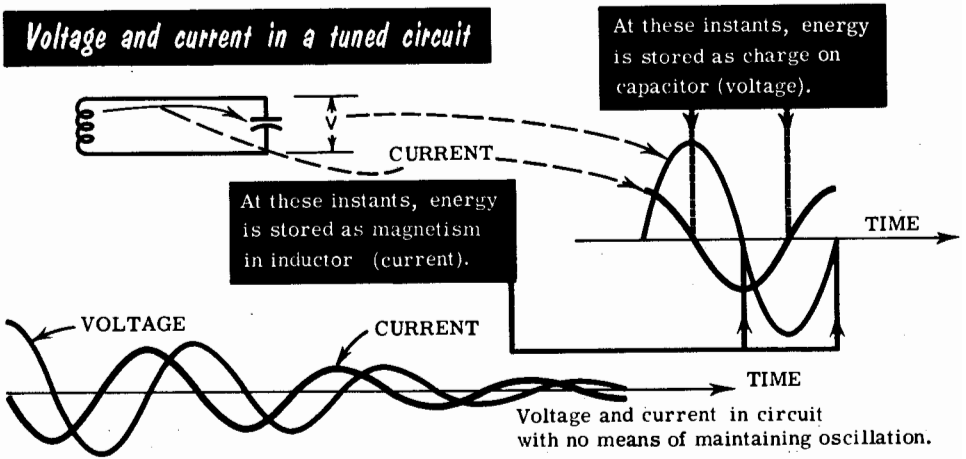

There are three basic kinds of oscillators. One uses an inductor and capacitor in parallel to produce a tuned or resonant circuit in which energy passes between the inductor and capacitor at the resonant frequency of the circuit. All that is needed to use this circuit in an oscillator is to feed back enough energy to make up for that lost in every transfer due to the losses in the circuit. This is usually achieved by having the tuned circuit in either the plate or grid circuit of a tube and using the amplification of the tube to feed back some of the energy in the correct phase to maintain the oscillation.

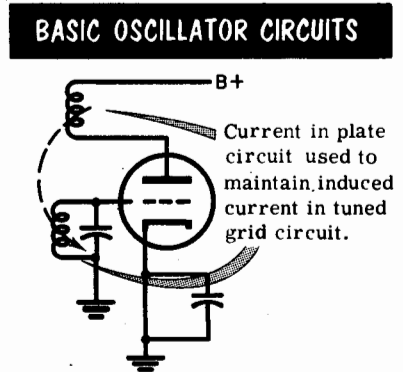
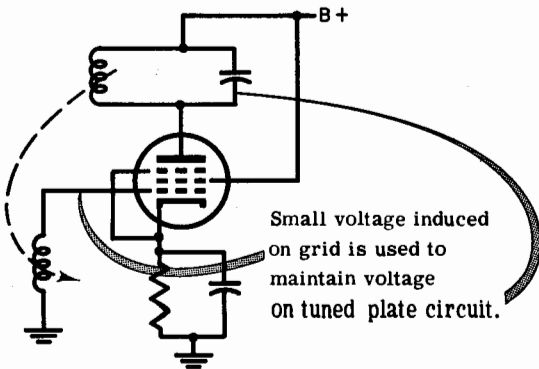

AUDIO OSCILLATORS

Phase-Shift and Positive Feedback Oscillators

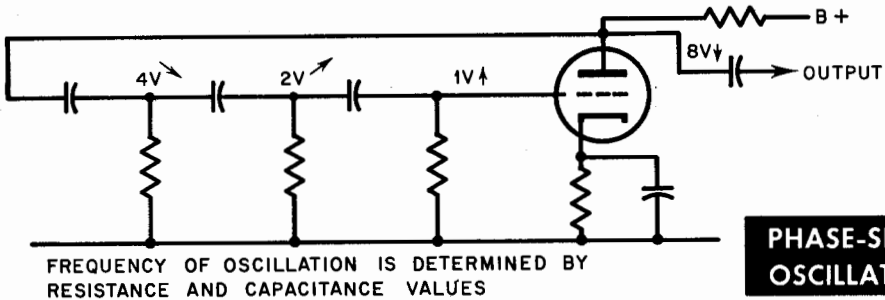

The other two types of oscillators do not use inductors because inductors can lead to various difficulties. They are, for example, likely to pick up magnetic induction, which can cause hum, or to pick up unwanted audio. The first of these oscillators uses a progressive phase shift to take advantage of the oscillatory condition of a feedback amplifier. The combination of successive resistors and capacitors are arranged to produce the phase reversal with a gain of 1 at a frequency that can be specifically controlled. This frequency can be adjusted by varying either the capacitors or the resistors.

The third type of oscillator uses positive feedback. The positive feedback is sufficient to cause oscillation at just one frequency. An arrangement of resistors with capacitors in series produces a loss of low frequencies. A capacitor in parallel produces a loss of high frequencies. The correct combination produces a maximum transfer of the positive feedback at one frequency with no phase shift. The amplifier oscillates at this frequency because the feedback is smaller at all other frequencies.

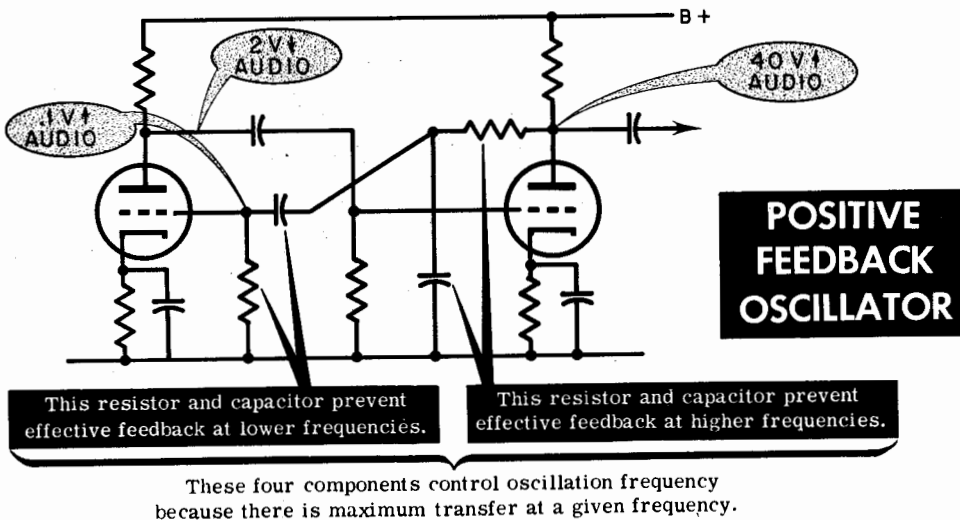

AUDIO OSCILLATORS

Improving the Output

The waveform of the positive-feedback oscillator can be improved by adding negative feedback. Positive feedback that provides 100% of the required input at the one frequency will provide at least half as much voltage at double this frequency. If the amplifier produces any non-linearity that would cause second harmonic distortion, there will be at least a 50% positive feedback of the second harmonic as well as 100% feedback of the fundamental. If the tube causes third-harmonic distortion, there will be at least 33% positive feedback for it as well. For this reason, the positive-feedback oscillator produces considerably more harmonic distortion than either of the other types.

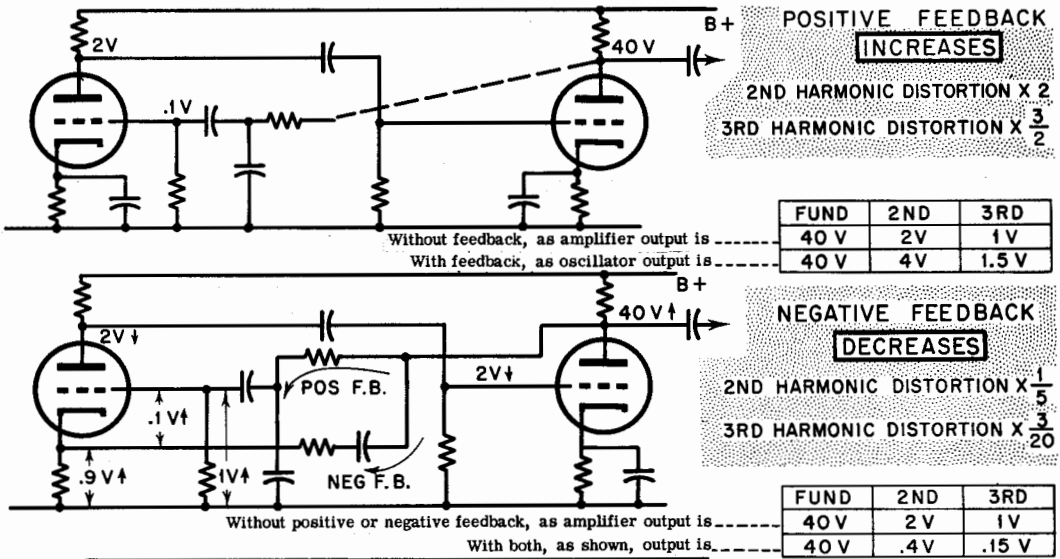

Negative feedback with positive gives lower distortion

By combining frequency-selective positive feedback with *negative* feedback that is not frequency-selective, distortion can be reduced. Suppose that the negative feedback produces an $A\beta$ of 9, while the positive feedback produces an $A\beta$ of 10. The net positive feedback is $(10 - 9)$ or 1 — still 100%, to allow oscillation. At double the fundamental frequency the positive $A\beta$ is only 5, while the negative feedback will still be 9. This means that the second harmonic will have a predominant negative feedback of $(9 - 5)$ or 4. Without the negative feedback, there is 50% positive feedback of the second harmonic, resulting in a 6-db increase. The combination of negative with positive feedback results in a 14-db negative feedback, reducing the second harmonic distortion of the oscillator to $\frac{1}{5}$, and higher harmonics even more. Thus, the positive and negative feedback arrangement inherently produces better sine waves than any other kind of audio oscillator.

AUDIO OSCILLATORS

Oscillator Waveforms

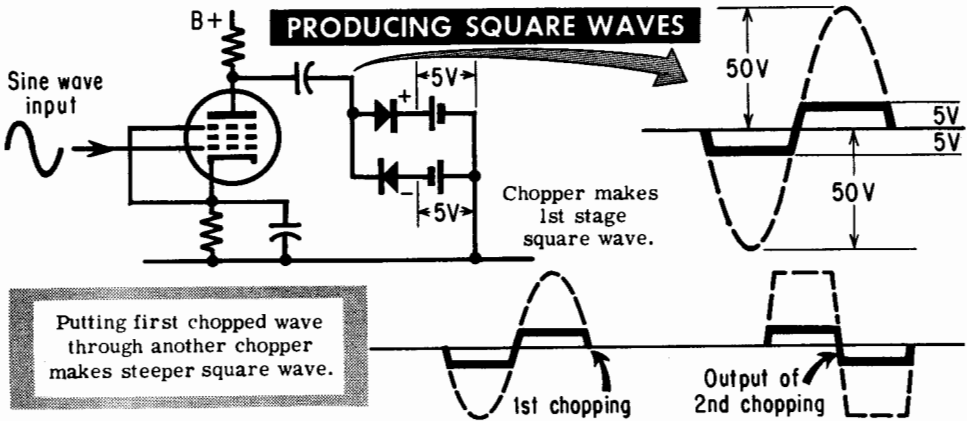

Audio requires waveforms other than sine waves. Square waves used in transient tests can be produced simply by amplifying sine waves in a circuit using diodes that start to conduct when the voltage reaches a specified point. This kind of circuit chops off the top and bottom of the sine wave, making something very much like a square waveform. If 9/10 of the sine wave is chopped off, the slope of the line joining the horizontal sections is very nearly vertical. The sides can be made even steeper by amplifying this wave again, and again chopping off 9/10 of it.

Sawtooth waves are made by a variety of means. A simple one is a circuit in which a steady current flows into a capacitor until the voltage across it reaches a specified point. This starts a quick feedback action through a couple of tubes that rapidly discharges the capacitor to its original level, from which it starts the charging sequence all over again. The sawtooth waveform is used for the sweep voltage in oscilloscopes and in electronic musical instruments as a basis for the variety of musical tones. A sawtooth wave has a very useful combination of fundamental with *all* of its harmonics, whereas the square wave possesses only the odd harmonics.

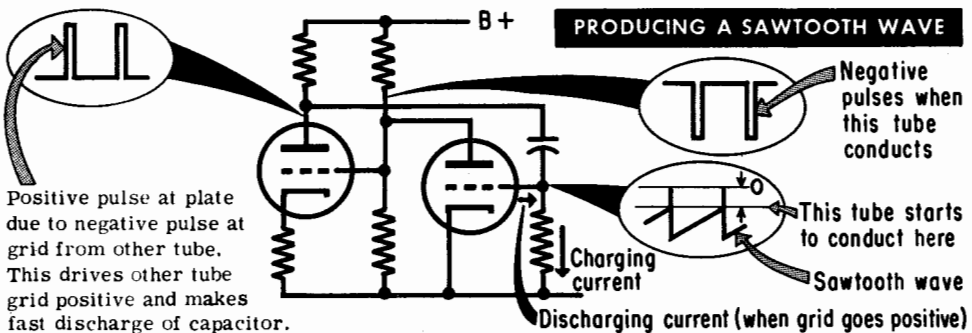

QUESTIONS AND PROBLEMS

1. Shielding prevents what three kinds of induction? In what ways can this induction occur?
2. What effect does circuit impedance have on the relative importance of the different ways induction occurs? Explain.
3. What are the essential features and characteristics of (a) magnetic, (b) electromagnetic, and (c) electric shielding?
4. Explain the advantages and limitations of coaxial lines.
5. Give the deficiencies associated with using lines at high and low impedance that lead to choice of a medium line impedance. What are common values of line impedance?
6. How can a condition near to instability (oscillation) cause distortion due to transient effects? Explain this possibility with reference to both low- and high-frequency near-instability.
7. Describe a group of transient effects in amplifier performance that is essentially caused by power supply features.
8. Name four major types of oscillator designed to produce sine waves. Explain the principle of operation of each. Which give the best waveform? Show why.
9. What other types of waveform are required from oscillators, and for what purposes?
10. A tube used in an oscillator circuit amplifies with the production of 5% harmonic. What positive and negative loop gain figures must be used so the output from this oscillator is 0.1%?
11. What is the essential difference between the phase-shift and positive feedback types of oscillator?
12. What difference is there, from a musical viewpoint, between a square wave and a sawtooth?

RECORDING

Uses for Recordings

Applications for Recording
Hi-Fi System, Motion Picture, Computer Memory Unit,
Aircraft Vibration Analysis, Industrial Process Control

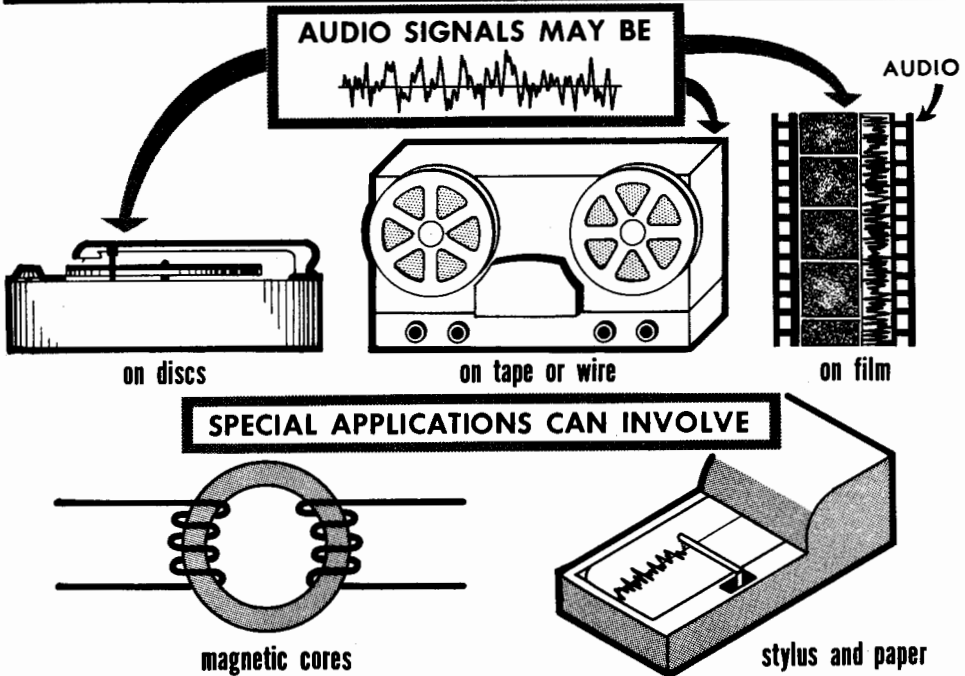

Recording plays an important part, not only in audio for high-fidelity purposes, but also in the many other applications for which modern audio equipment is used. It can be regarded as a storage medium in which long sequences of audio waveforms can be indefinitely preserved for reproducing at a later date.

In the case of high fidelity, this audio waveform sequence may be a complete musical performance. For computer and other industrial applications, the sequence may be any audio waveform combination representing information. It may be a record of the vibrations that occur in different parts of a supersonic missile in flight or a record of the progress of a certain industrial process that requires careful comparison of the results of the process in successive hour periods. By recording the data during a complete hour and then comparing the result with the corresponding data exactly one hour later, the process could be continually controlled. A variety of media are used for storing audio material: disc, tape, wire, and film.

RECORDING

Disc Recording Techniques

In disc recording, grooves are cut on a smooth surface by means of a cutting stylus. Later on the pickup stylus will follow the same groove and reproduce the mechanical vibration that cut the original groove. The grooves can be cut two ways: from side-to-side (*lateral*) or up-and-down (*vertical*).

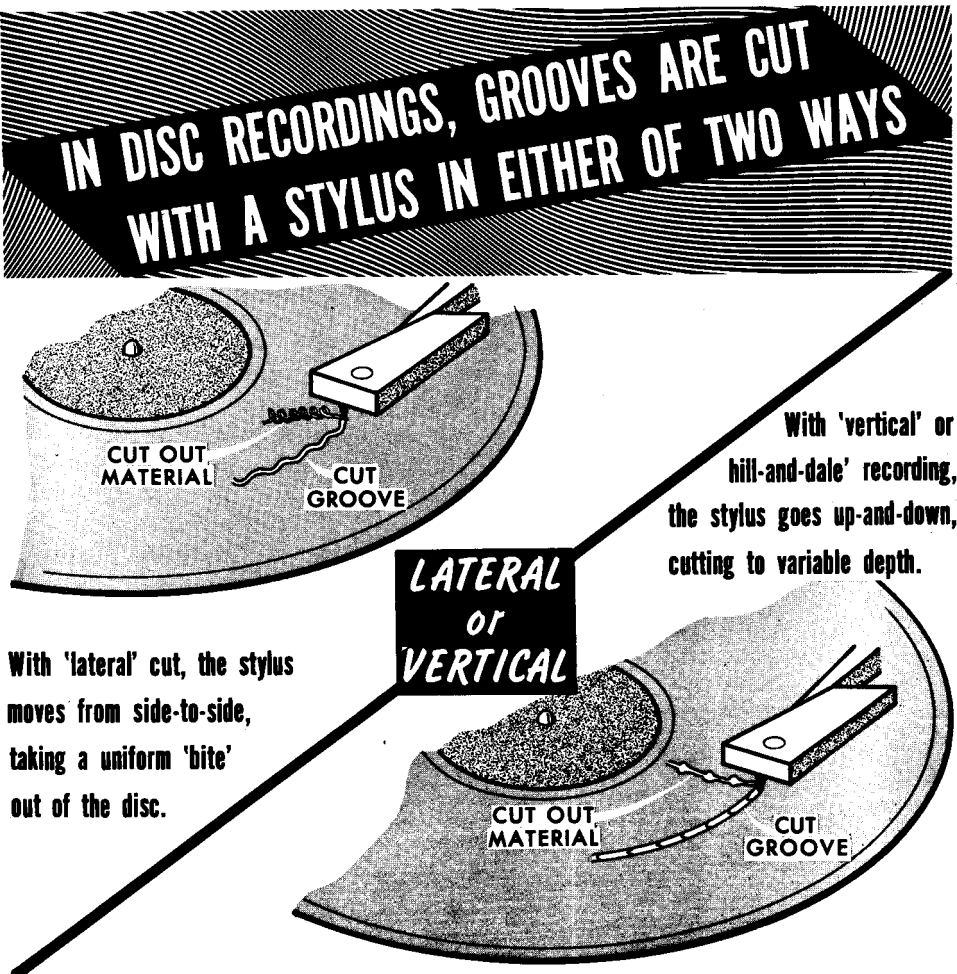

Lateral cuts are invariably used in modern recordings, because this method involves continuous removal of the same amount of material (called *swarf*) from the surface by the cutter. Vertical (hill-and-dale) cutting involves variation in the amount of material removed at the different points on the waveform, which places a varying load on the cutter. This variation in itself can cause distortion.

RECORDING

Cutters and Pickups

The action of pickups and cutters used on discs can be regarded as similar to the action of microphones and loudspeakers with sound waves. The principal difference is that pickups and cutters only move back and forth in a specific direction, whereas sound waves distribute themselves in a more complicated manner. In addition, the material in the disc is heavier than air. Consequently, the mismatch problems met in making the diaphragm of the microphone or loudspeaker act uniformly over a wide range of frequencies are not present. The loading effect of the disc material better controls the action of the cutter or pickup stylus to produce uniform results, than does the loading action of the air on the microphone or loudspeaker diaphragm. Common varieties of cutters and pickups include the magnetic, moving coil, ribbon, crystal or ceramic, and capacitor types.

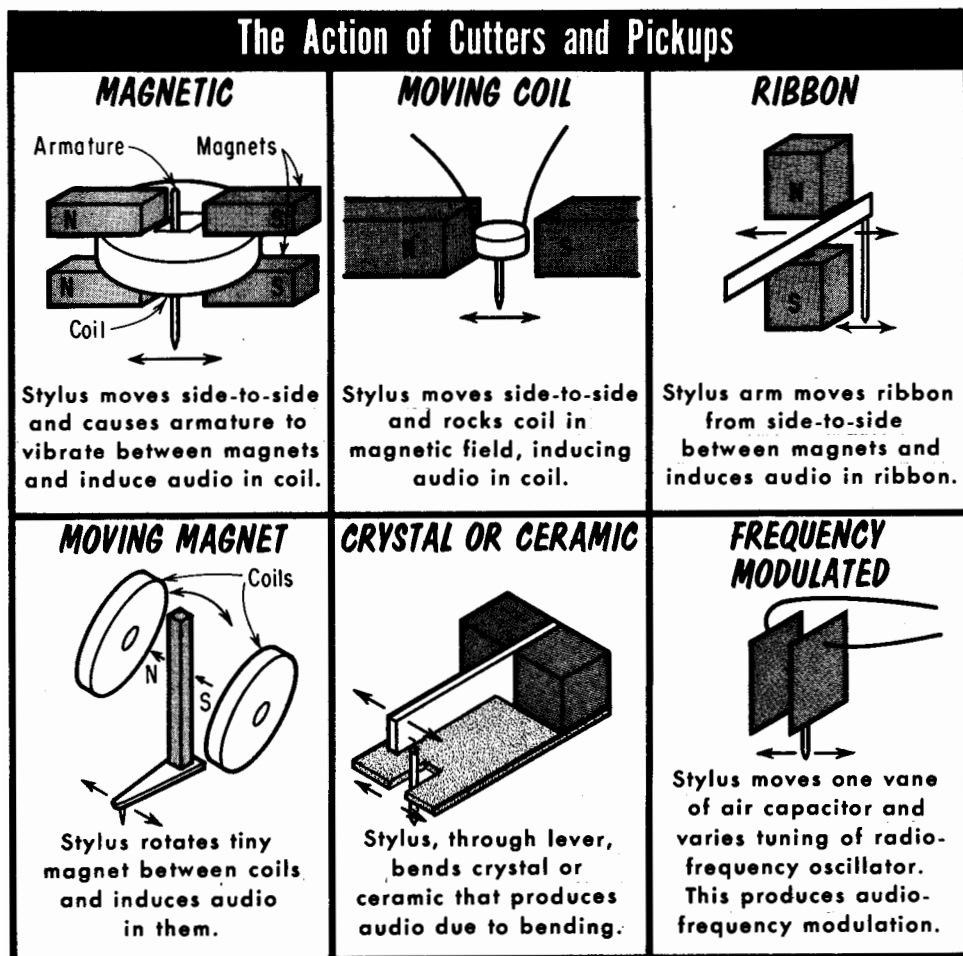

RECORDING

Velocity and Amplitude Systems

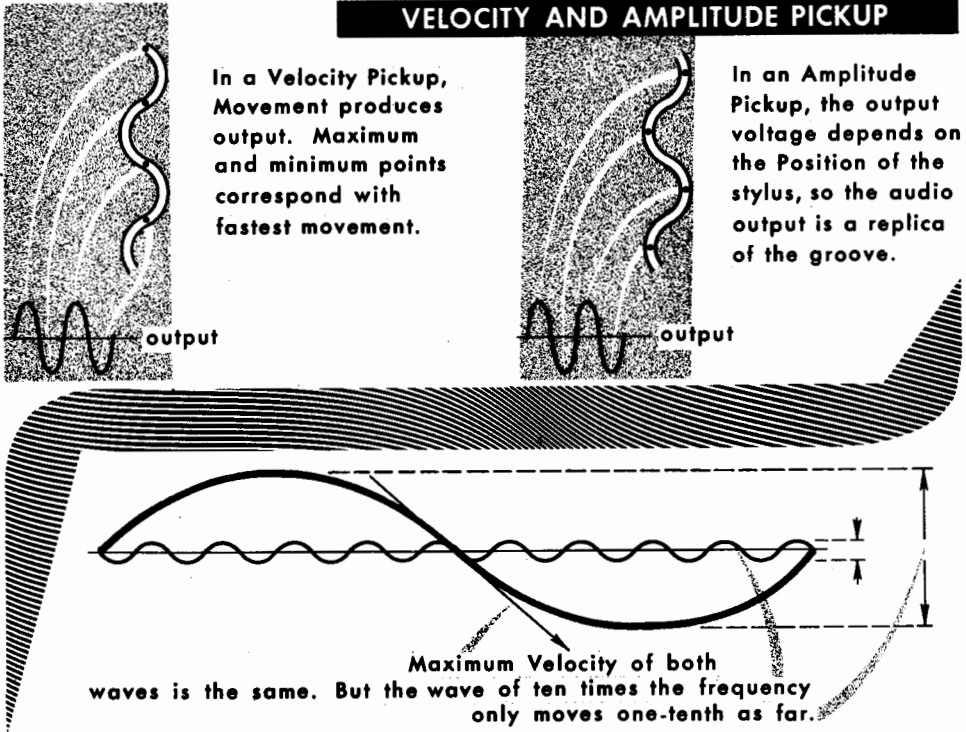

As well as different kinds of transducers for the cutter or pickup head, there are different principles of operation; some work on a *velocity* principle in which the output voltage is proportional to the *rate* at which the stylus moves. Others work on an *amplitude* principle in which the output voltage is proportional to the *amount* that the stylus moves. The velocity-type transducers include the magnetic, moving coil, and ribbon. The amplitude-type transducers include the crystal or ceramic and the capacitor.

The important difference between these types is in the kind of frequency response that they produce. If the disc has grooves of equal magnitude from side to side at different frequencies, the amplitude-type pickup will give a flat response. The rapidity with which the stylus moves is, however, proportional to frequency; hence, this type of recording would produce an output proportional to frequency, if the pickup were of the velocity kind. (This would require special equalization on playback.)

To produce a recording of the velocity kind that gives uniform output with frequency, the amplitude must vary *inversely* with frequency. (Doubling the frequency must halve the amplitude, so that the maximum rate at which the stylus moves at the different frequencies will be constant.)

RECORDING

Velocity and Amplitude Systems (contd.)

Standards of disc recording have been based on the *velocity* principle, using magnetic, moving coil, or ribbon type transducers for cutters or pickups. Assuming a recording from 20 cycles to 20,000 cycles, this would mean the *magnitude* of movement to give the same output at 20 cycles would be 1000 times what it is at 20,000 cycles. Obviously, this would be impractical. If the movement is 1/10,000 inch at 20,000 cycles, 1/10 inch movement will be needed at 20 cycles. 1/10,000 of an inch is so small that the roughness of the record will make more noise than the signal recorded; on the other hand, 1/10 of an inch is so wide that it would be impossible to get more than 10 grooves to the inch.

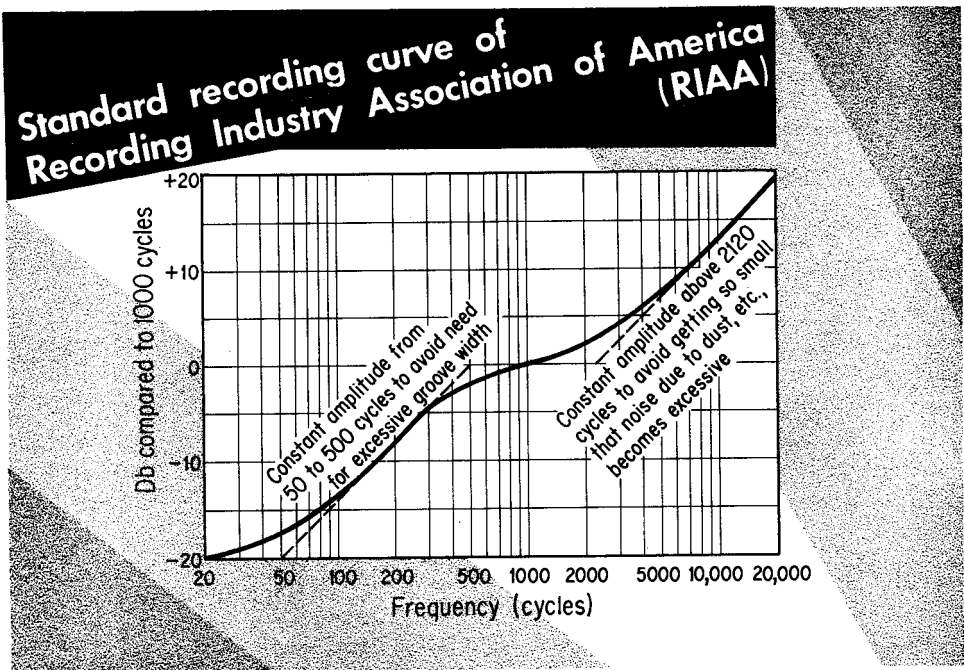

For this reason, there must be a change at some point to constant-amplitude recording. The Recording Industry Association of America (RIAA) puts this turnover at 500 cycles. To overcome the fact that the extremely small movement, above, say 10,000 cycles, would mean that the surface noise would be louder than the audio, constant amplitude is also applied above a frequency of 2,120 cycles. These two changes from the velocity characteristic avoid excessive stylus movement at low frequencies and prevent noise from overriding the audio at high frequencies. This varying frequency response is provided by an equalizer in the recording amplifier and must be compensated for by opposite equalization in the playback amplifier.

RECORDING

Magnetic Recording



On wire, the magnetism is in alternate directions along the wire.

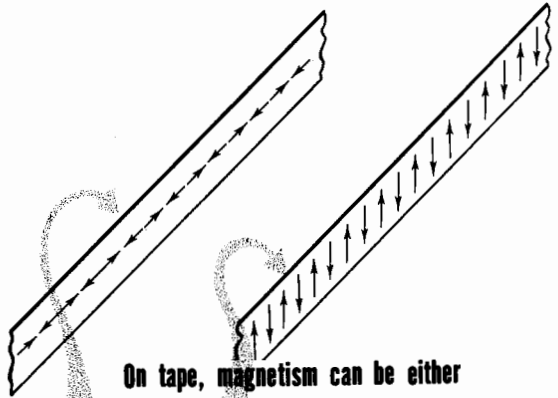

On tape, magnetism can be either lengthwise or crosswise. Lengthwise is most used.

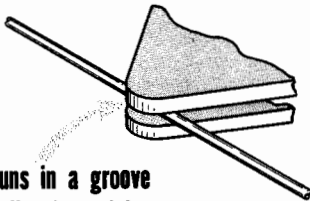

Wire runs in a groove in the 'head,' which otherwise is like tape head.

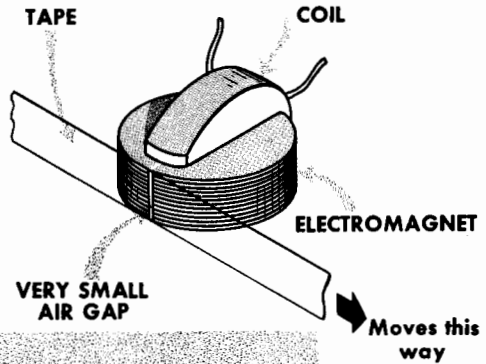

Tape and wire recording use a magnetic pattern corresponding to the audio, which is put onto a magnetic material that will hold it indefinitely. The additional track width on tape permits more magnetism to be put on it, giving a better discrimination of audio against background noise.

Part of getting a good recording depends on using a completely demagnetized tape. This is achieved by using an *erase head*, which the tape passes before it reaches the *record head*.

RECORDING

Ultrasonic Erase and Bias

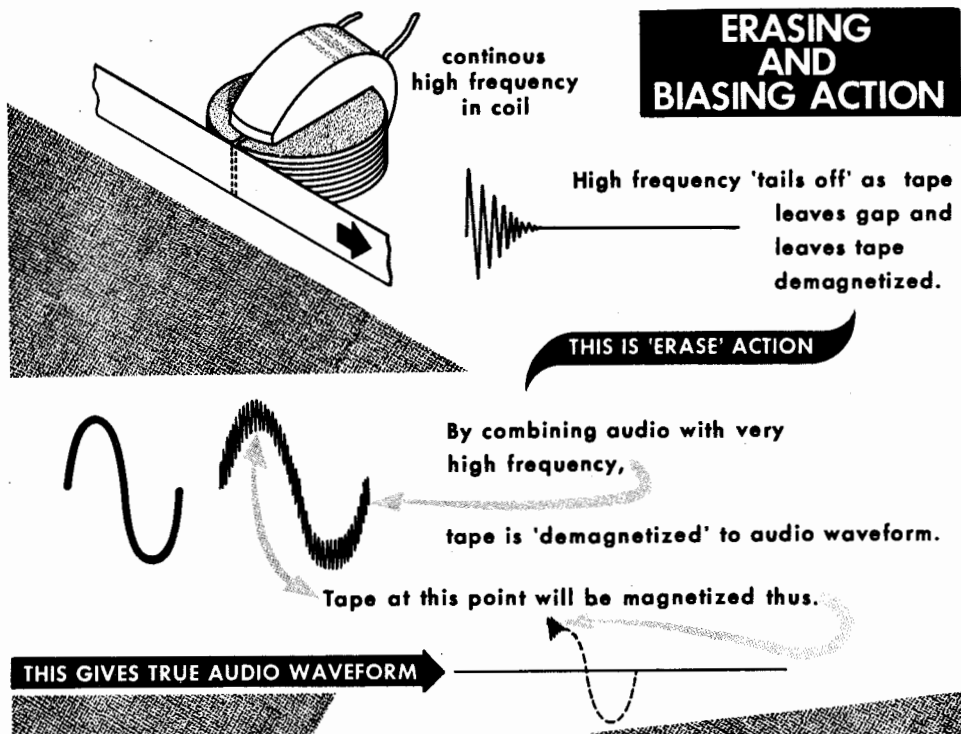

The best form of erase uses an ultrasonic oscillator. As the tape passes the magnetic gap, the magnetization due to the oscillator signal alternates several times because of its very high frequency. As a result, the magnetization cancels out as the tape leaves the gap, ultimately demagnetizing it. This type of erase is necessary because of the *hysteresis* effect in any magnetic material. Too little reverse magnetism does not demagnetize; too much re-magnetizes in the opposite direction. Repeated magnetization at ever decreasing intensity reduces the magnetism until the tape is completely demagnetized.

This hysteresis action in magnetic material is responsible for very drastic distortion, unless something is done about it. The simplest way to eliminate this distortion is to use ultrasonic bias. The audio is combined with some of the same high-frequency signal used for erase. The supersonic bias is quite strong, compared to the smaller audio fluctuations at least (full-amplitude audio will be about equal to the bias). As the tape leaves the gap and the demagnetizing action of the ultrasonic frequency fades out, the magnetism left on the tape is the audio component, which does not fade out, because its fluctuation is much slower (only a fraction of a cycle, instead of many times, while the tape is passing the recording head).

RECORDING

Tape Response

With magnetic recording, the output from the tape passing the gap is proportional to the rate at which the magnetism changes. Consequently, it will rise with frequency, at least up to a point where the length of the effective magnet on the tape is about the same as the air gap on the head that is used to pick up the magnetization. When the frequency gets higher than this, the air gap will start to compare the magnetization on the tape at half a wavelength or more, and cancellation begins to occur.

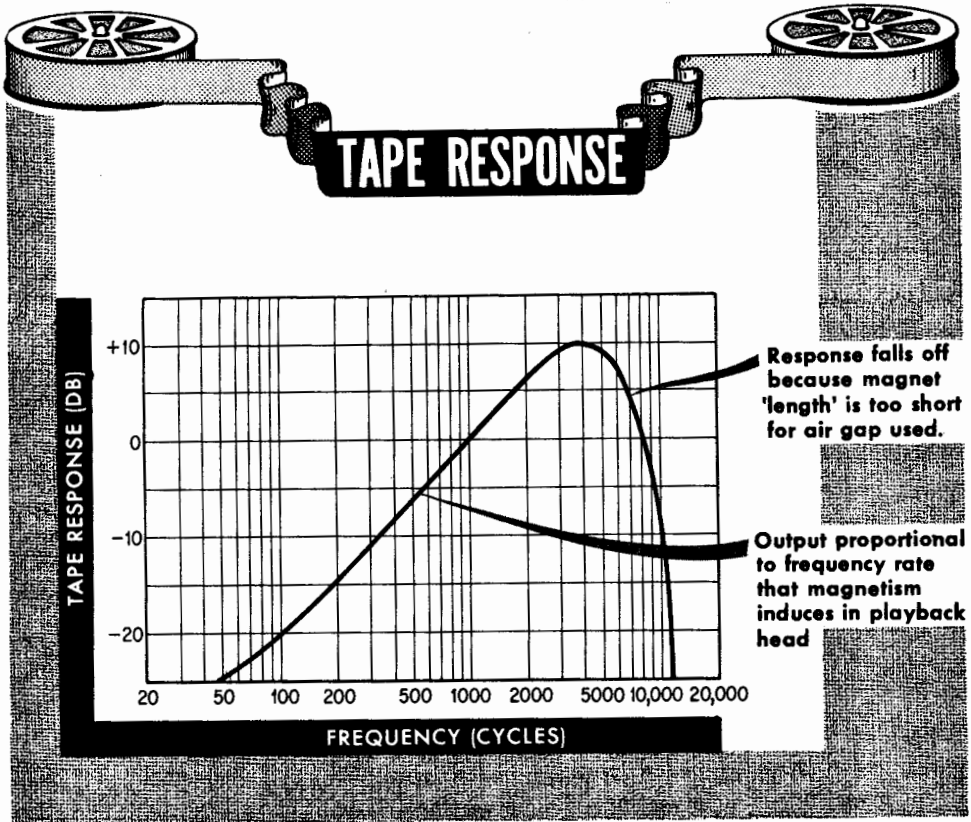

This means we get a rising response all the way up to a certain frequency (which is dependent on the width of the air gap and the speed of tape travel), which falls off very suddenly to zero. Equalization of the input signal, the output, or both, compensates for the characteristic. The magnetization on the tape theoretically is proportional to the current applied to the recording head. This does not allow for losses in the head, however, which complicate the response somewhat. Because of these complexities, only playback response is specified.

RECORDING

Film Recording

Film Recording

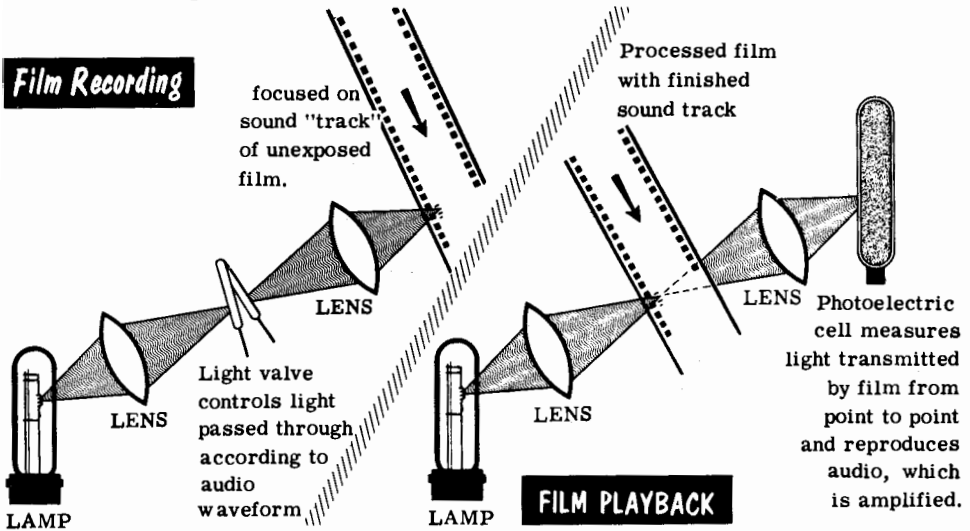

Film recording is usually achieved photographically by producing an exposure on the film proportional to the instantaneous audio. This is accomplished by means of a light "valve" that controls the amount of light falling on the film as it passes by a slot. In playback, the same film, with the recording photographically reproduced on it, is scanned by means of a photoelectric cell, the output from which is amplified by an audio amplifier.

Because the photoelectric cell is sensitive to the quantity of light, the sound track on the film can vary either in the area through which light passes or in the transparency (density) of the film. Both methods have their uses, their advantages and disadvantages, which are concerned more with light and optics than with audio. As with the other methods of recording, special equalization is required on playback.

VARIABLE "AREA"

Width of transparent part varies with audio.

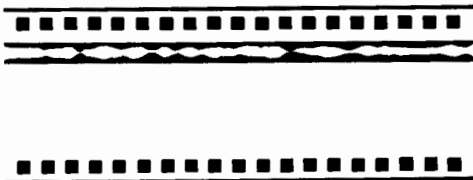

VARIABLE "DENSITY"

Whole track varies in density with audio.



RECORDING

The Effects of Wow, Flutter, and Rumble

No matter which type of recording is used, constant speed drive is a vital necessity, both for making and for playing back the recording. Variation in speed not only changes the rate at which the program is recorded or reproduced, but also changes its pitch or frequency. Turning a phonograph record faster raises all the frequencies by the same ratio, and the pitch steps up by a constant tone interval. While it is important to have the right speed, it is more important for the right speed to be steady. It must not warble up and down, or flutter up and down.

If a phonograph record is not mounted true, this will result in change in speed along the groove, which will cause pitch to vary once per revolution, an effect called *wow*. *Wow* can also be caused by variation in bearing friction as the turntable goes around. Variations in speed at a greater speed than once per revolution are called *flutter* because of the effect they produce on the reproduction. These effects can happen equally well to optical or magnetic recording, so careful mechanical design, to prevent any nonuniformity of speed, is needed with any recording drive.

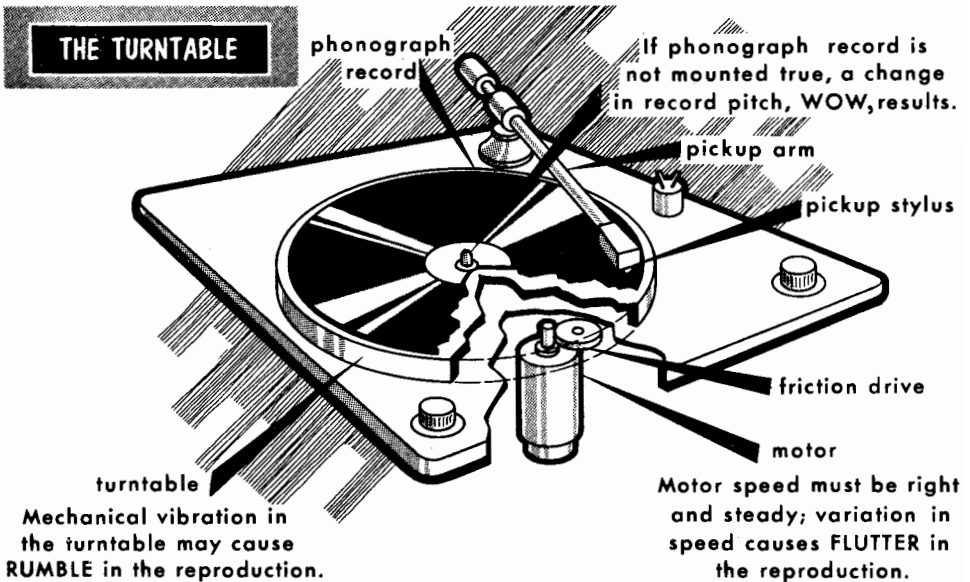

An effect most noticeable on phonograph recording, but entirely exclusive to it, is called *rumble*. This is caused by mechanical vibration in the turntable. The pickup stylus will be moved just as much by the whole groove vibrating as by vibrations that occur in the groove as it passes. Consequently any motor vibration that gets to the turntable will appear in the reproduction as rumble.

ELECTRO-ACOUSTICS

Acoustic Feedback

Complete audio systems involve some acoustics, by which we mean the way sound waves radiate, both in the air and through floors, ceilings, etc. The subject of concern in audio is called *electro-acoustics*, because it deals with the combination of electronic and acoustic effects.

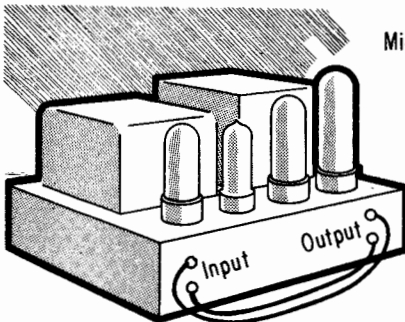

IF AN AMPLIFIED OUTPUT FEEDS BACK TO THE INPUT, IT WILL OSCILLATE.

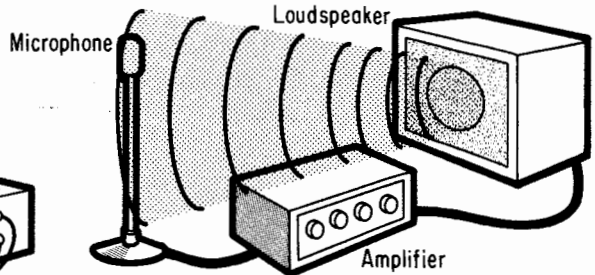

THE FEEDBACK CAN BE BY MEANS OF SOUND WAVES FROM A LOUDSPEAKER CONNECTED TO THE OUTPUT TO A MICROPHONE CONNECTED TO THE INPUT.

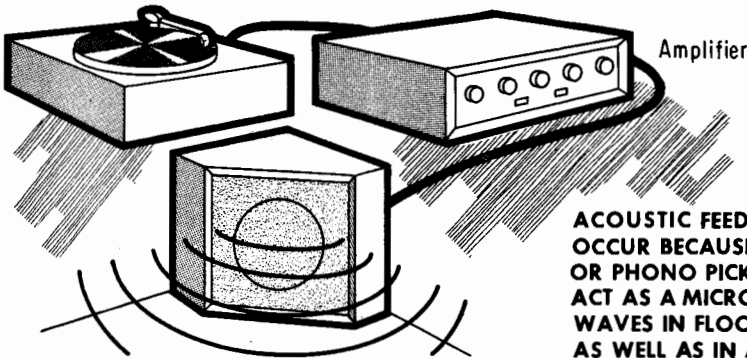

ACOUSTIC FEEDBACK MAY ALSO OCCUR BECAUSE AMPLIFIER TUBES OR PHONO PICKUPS SOMETIMES ACT AS A MICROPHONE TO SOUND WAVES IN FLOORS, WALLS, ETC., AS WELL AS IN AIR.

An amplifier can become unstable because high-level audio (electrical power) at the output is fed back to the low-level input circuits. It can also become unstable because high-level acoustic energy radiated from the loudspeaker is fed back to a microphone. This occurs in public address systems where the complete system consists of a microphone, an amplifier, and loudspeakers to reinforce the sound of the speaker on the platform, or the orchestra on stage. Acoustic feedback is not limited to systems possessing microphones; it can also occur in a home reproducing system due to a tube, or the phono pickup, *acting* as a microphone. It does this by picking up either sound waves from the air or acoustic vibrations coming through the floor or walls. For this reason, care has to be taken to insure that high-level vibration cannot reach the turntable, the pickup, or any of the amplifying tubes that handle low-level audio if they are at all microphonic.

ELECTRO-ACOUSTICS

Loudspeaker Damping

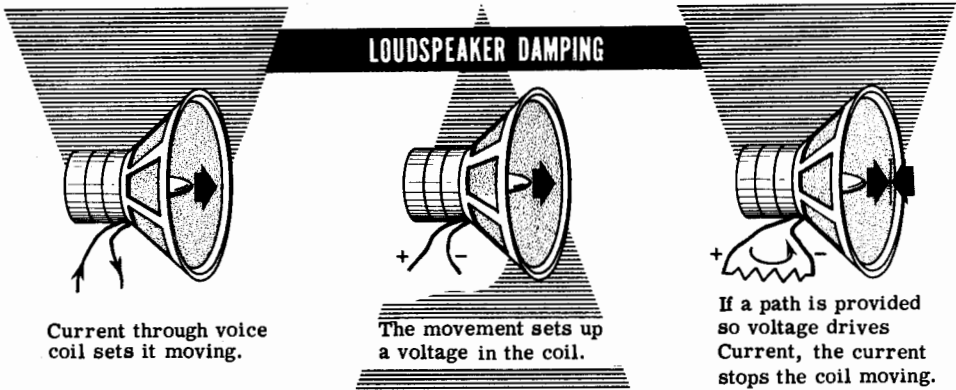

Another aspect of electro-acoustics concerns the proper coupling of the loudspeaker to the amplifier. Not only does the loudspeaker impedance have to be matched to the amplifier output impedance, but the output impedance of the amplifier affects the operation of the speaker. When the speaker diaphragm starts moving (due to an input signal from the amplifier), the momentum of the diaphragm will tend to keep it in motion even after the drive current has ceased. Diaphragm motion causes the loudspeaker to operate as a microphone, generating voltages in its voice coil. This overshoot movement will generate a further voltage. If the impedance of the amplifier is high, there will be a negligible current in the circuit due to this voltage. If the amplifier impedance is low, however, current flows producing a force that acts to stop overshoot.

This means the source resistance presented by the amplifier will influence the behavior of the loudspeaker. A low source resistance will prevent the voice coil overshooting, while a high source resistance will allow the voice coil to move erratically and affect the transient response of the loudspeaker. This means that the source resistance presented by the amplifier, due to the plate resistance of the output tubes, adjusted according to any positive or negative feedback, will influence the behavior of the loudspeaker.

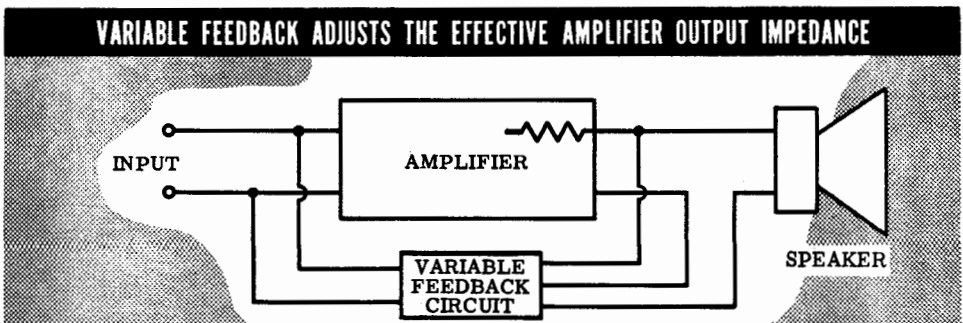

ELECTRO-ACOUSTICS

Loudspeaker Damping (contd.)

The effect of source resistance on loudspeaker behavior is called the *damping factor* of the amplifier. Because a higher source resistance damps or brakes overshoot less than a low source resistance, the damping factor is given by the load resistance *divided* by the effective source resistance.

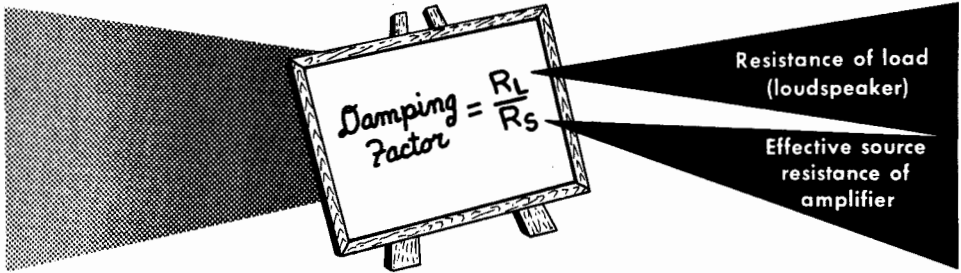

The use of a high damping factor (or a low source resistance) cannot do everything. The electrical damping has to act on the motional impedance of the loudspeaker. (Motional impedance is the impedance reflected back to the loudspeaker terminals due to the movement of the diaphragm.) This impedance is only a small fraction of the total impedance of the loudspeaker, most of which is due to the resistance and inductance of the voice coil.

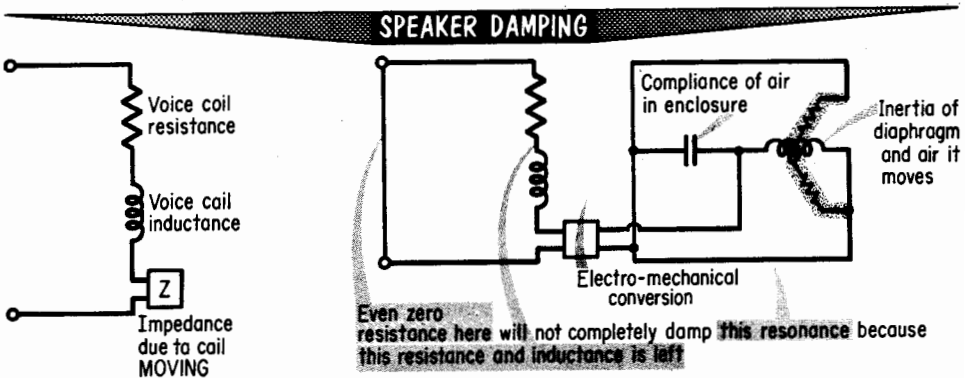

For this reason, the loudspeaker is quite inefficient. The greater part of the power delivered to it by the amplifier is expended in the voice coil resistance and merely heats the voice coil, whereas only a relatively small proportion is radiated as sound, due to the motional impedance. Only a correspondingly small fraction of the speaker's output is available for damping. Hence, even an infinite damping factor would have a limited effect on mechanical or acoustic resonance. The resistance of the voice coil (which cannot be eliminated) limits the damping current.

ELECTRO-ACOUSTICS

Demonstration of Acoustic Damping

For this reason, the best way to achieve good operation of a loudspeaker is to damp its movement *acoustically* by attention to the construction of the loudspeaker enclosure. This can be illustrated quite effectively by mounting a loudspeaker in a simple enclosure with three alternatives for the back of the enclosure.

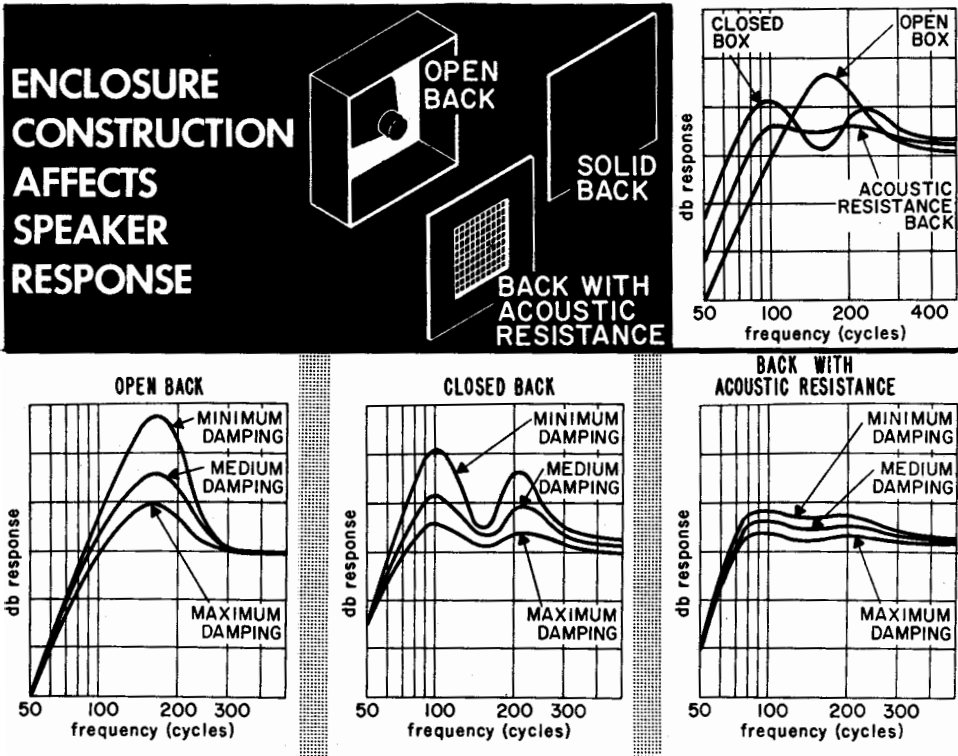

A completely open back results in a load on the diaphragm that acts as a mass or weight of air moving bodily. A completely closed back makes the air inside the cabinet act as a compressible cushion. Using an acoustic resistance consisting of a large number of holes that allow the air to pass through but offer resistance to its passage achieves an intermediate condition that damps the diaphragm properly.

Comparison of results shows that the response is much smoother with the acoustic damping and that under this condition, electrical damping becomes unimportant. With either the solid or the open back, electrical damping from the amplifier makes a considerable difference to the response of the loudspeaker, but neither performance is as good as that with the acoustic resistance.

AUDIO AND HEARING

Characteristics of Hearing

As discussed in Volume 1, the fact that we have two ears permits us to tell from which direction sound is coming. This permits us *subconsciously* to distinguish direct from reflected sound and to concentrate on what we wish to hear. At a live performance of a symphony, for example, we can concentrate on the sound coming to us from the orchestra and ignore the effects of reverberation. The degree to which this is true can be shown by placing a microphone in the position at which we were listening. The microphone cannot distinguish between direct and reflected sound, and a recording made in this way seems to have far too much reverberation. The sound reproduced through a loudspeaker seems quite confused because our hearing cannot separate direct and reflected sound now that they both come from one source.

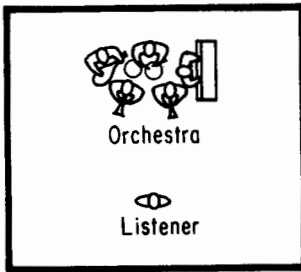

ORIGINAL SOUND REACHES LISTENER FIRST.

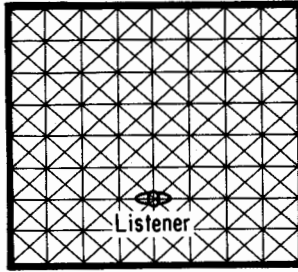

THE REVERBERATION PATTERN BUILDS UP ALL AROUND HIM

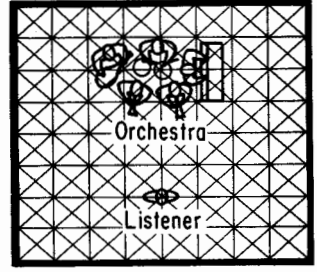

TO GIVE A COMPOSITE EFFECT.

Effects of Live and Recorded Sound

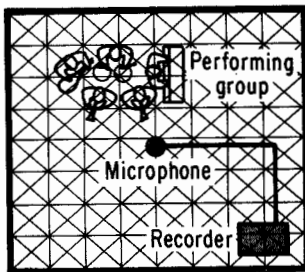

ORIGINAL PROGRAM SOUNDED LIKE THIS.

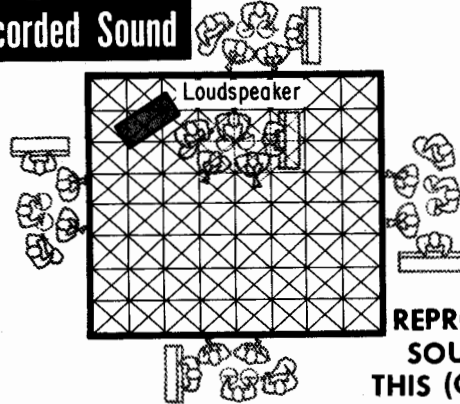

REPRODUCTION SOUNDS LIKE THIS (CONFUSED)

The ability to concentrate in hearing permits us to carry on a conversation with one person in a crowded room. The sound of his voice is probably no louder than that of anyone else's (and certainly no louder than all of the others together), yet, by concentrating, you can hear what he is saying, almost to the exclusion of all other conversations going on around you.

AUDIO AND HEARING

The Physiology of Concentration

Concentration is aided by two things: your sense of direction (which helps you to concentrate on sound coming from where your friend is standing) and the individual characteristics of his voice (his "voice personality") which helps you to separate what he is saying from what people with different voice personalities are saying. How is this discrimination achieved, when all we can really tell apart (in audio terms) is the frequency content and the intensity of individual frequencies.

It is all possible due to the form that individual hearing perception takes in its transmission from the individual ears to the brain. Each ear has a number of resonators in the cochlea that are sensitive to individual frequencies, using from 20 to 29,000 to cover the entire audio frequency range. Each of these *receptors*, however, does not transmit its individual frequency to the brain. What it does transmit is a series of nerve pulses.

The first pulse to be transmitted to the brain is sent when that particular frequency is first detected by the ear. Thereafter, a sequence of pulses is sent along the same nerve fiber, dependent upon the intensity of that frequency at the instant. The louder the sound component of the particular frequency, the more frequently this nerve carries pulses to the brain.

The section of the brain devoted to the analysis of sounds heard "recognizes" a complicated pulse pattern by comparison with patterns already familiar. There are a number of characteristics by which the patterns can vary, enabling deliberate "differential listening." The most important part of any group of patterns is the first set of pulses along any particular grouping of nerve fibers. This is the transient effect of the sound heard. The following grouping indicates the way the sound varies in intensity or tone quality after it first starts.

The auditory nerve conveys to the brain a pulse code pattern corresponding with all the sounds being heard all the time. The code can be decoded in a variety of ways because of its enormous complexity and the vast resources of the brain cells that interpret sound. Sounds can be grouped, for example, according to the particular pattern of fundamental and overtones characteristic of a violin. Thus, when listening to orchestral music, the sound of the violin can be distinguished from all the other musical sounds going on at the same time. Similarly, one person's voice can be singled out from the voices of many other people by noticing the pattern peculiar to that person's voice personality. The automobile mechanic's ear becomes tuned to the sound patterns that come from each component in an automobile engine. As a result, he can distinguish a sound due to a knock in an end bearing as different from one due to loose valve tappets, among all the other engine noises.

Although the hearing faculty is extremely critical and can detect any particular sound with high precision, it is also extremely tolerant: it can pay attention to what it wants to hear and ignore everything else.

AUDIO AND HEARING

The Physiology of Concentration (contd.)

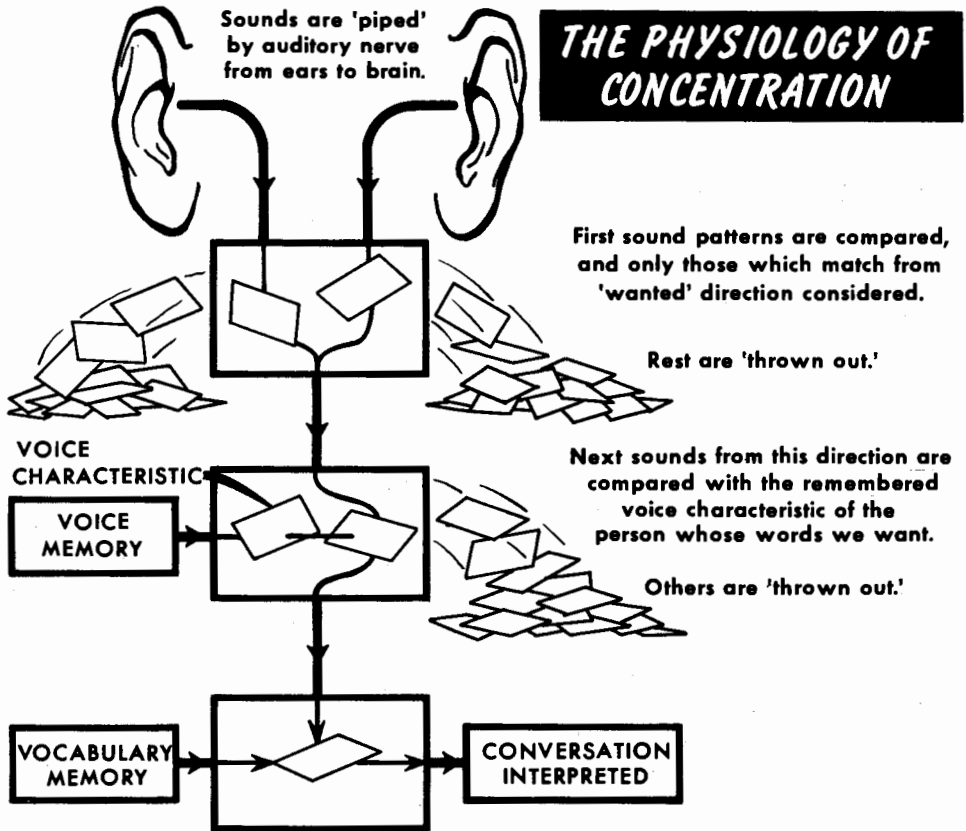

HOW WE CAN HEAR SELECTIVELY

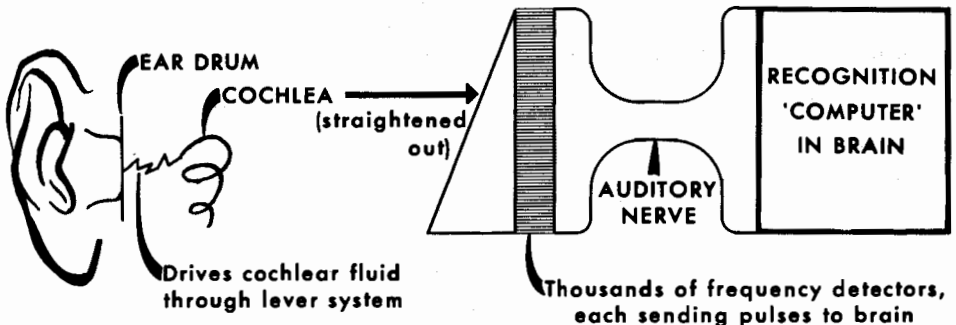

EACH NERVE SEPARATES A "NEW" PULSE FROM FOLLOW-THROUGH ONES OF THE SAME FREQUENCY.

AUDIO AND HEARING

Binaural Reproduction

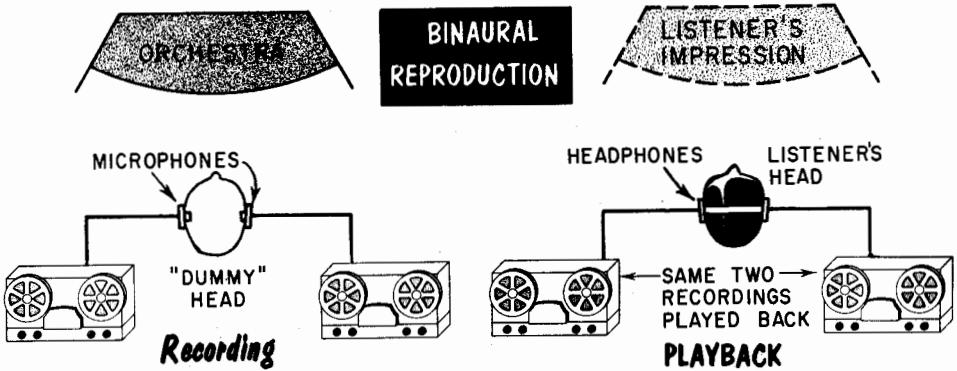

This brings us to some final aspects in achieving realism in high-fidelity reproduction: the artificial reproduction of sound that gives an impression of coming from different directions and enables the hearing faculties to draw similar conclusions to those that would have been received in the original program.

There are two main approaches to this objective. One uses a dummy human head with a microphone in the position of each ear and makes two-channel recordings. By means of a pair of headphones, one of these channels is delivered to each ear of the listener when the record is played. This system is called *binaural* reproduction. This same two-channel sound could be reproduced over two loudspeakers, but the effect would not be as good. When sound is released into the room by two loudspeakers, the waves from each loudspeaker reverberate around the room and recombine. The impression conveyed to each ear in this way is not the same as that conveyed by the earphones and the sound field created is not like the original field.

TWO-CHANNEL SOUND USING TWO LOUSPEAKERS

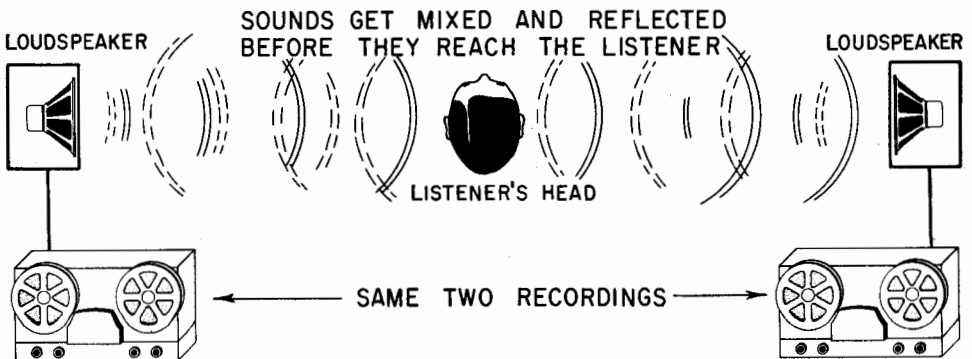

AUDIO AND HEARING

Stereophonic Reproduction

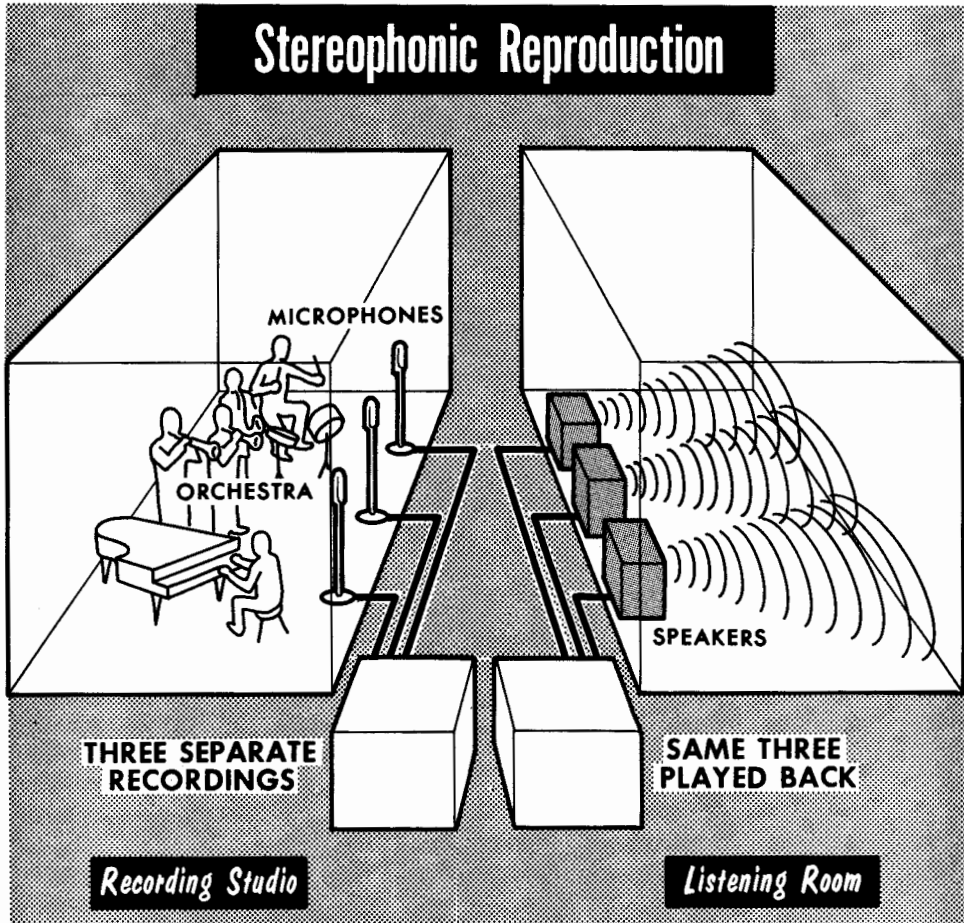

The stereophonic technique of reproduction takes the approach of endeavoring to recreate an original sound *field*, avoiding the necessity for wearing headphones. To do this, the recording microphones are spaced a given distance apart and the loudspeakers are spaced a similar distance apart. This, to some extent, recreates the original time and phase differences that set up the directional effect in the sound waves. It cannot completely achieve the desired result because the acoustic characteristics of the listening room as well as those of the studio are present. (The original sound field will never be fully recreated because of the additional reverberation added in the listening room.) If the reverberation in this listening room is reduced by putting very absorbent material on all walls, the floor, and the ceiling, the sound is still unnatural because then the reverberation would not appear to come from all directions in the same way as it did in the original performance.

AUDIO AND HEARING

Stereophonic Reproduction (contd.)

In practice, the program is recorded in a studio that has less reverberation than the final reproduction should have, which permits the listening room characteristics to complete the sound pattern. It is better to allow the sound pattern to be slightly different from the original, but still a *credible* reproduction of it, than to try to reproduce the original sound exactly and fail in some more important aspect.

STEREO HAS ITS PROBLEMS

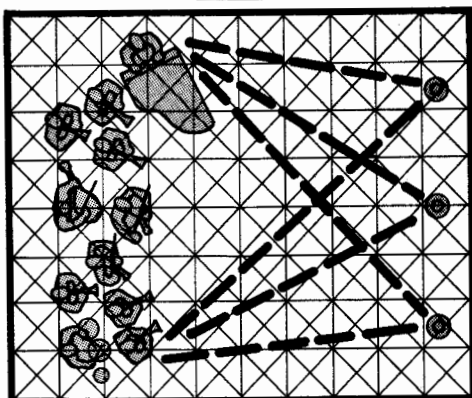

Original studio reverberation is recorded.

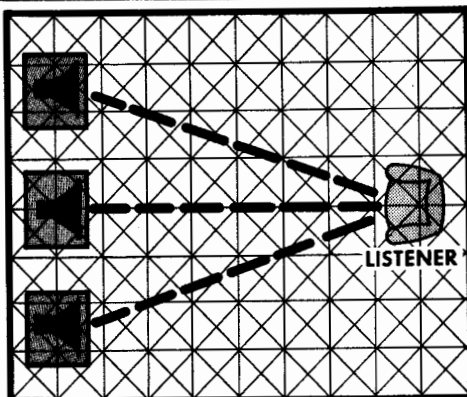

Playback room adds its own reverberation.

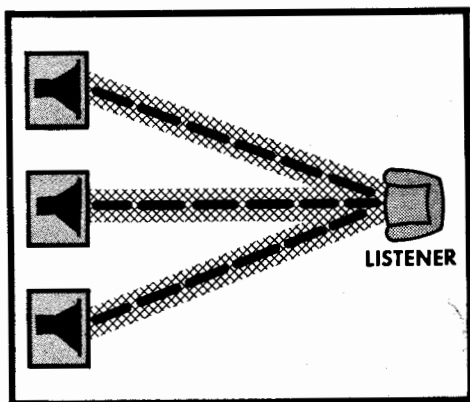

Using a 'dead' room eliminates playback room reverberation but the recorded reverberation comes with the original sound, which is still not natural.

For this last reason, it is particularly important in stereophonic reproduction to pay particular attention to how transients reach the listener and the method by which the reproducer systems throws them out into the room. If the transient pattern is a realistic recreation of the original, the reverberation effects will be relatively unimportant.

AUDIO AND HEARING

Stereophonic Reproduction (contd.)

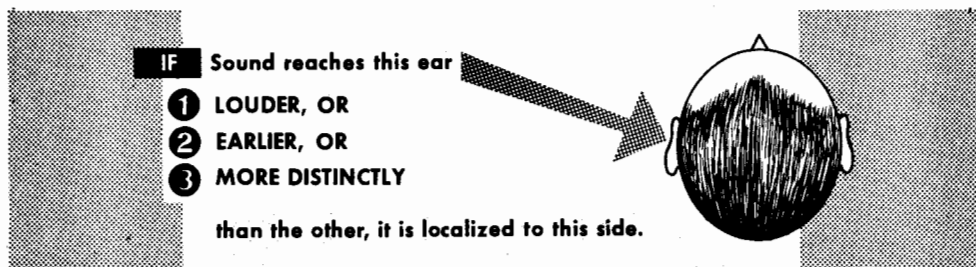

The ability of our hearing faculty to locate sound sources depends on three main differences in the sound at our two ears: *intensity*, *time*, and *quality*. If one sound is stronger at one ear than the other, the apparent direction is toward the side where it is received the strongest. If the sound is heard by one ear a fractional interval before the other, it will seem to come from the direction where it was heard earliest. Finally the hearing faculty notices the frequency content reported by both ears. It will also interpret a clearer sound, because more of the higher frequencies are present, as meaning that the sound originates from that side.

The hearing faculty uses all of these differences at once, but the relative importance it attaches to each will depend on room acoustics. In a big, reverberant room with a lot of echos, whether these are noticeable separately or just add confusion, time difference becomes almost meaningless. So our hearing concentrates on the other differences. In a smaller room, where reverberation is almost absent (and by the very size of the room, intensity must equalize somewhat), the hearing faculty gets extra critical about time differences.

This means that, in a large room, wide-spaced speakers fed with audio in which the intensity corresponding to different locations is emphasized will give the best stereo. In a small room, wide spacing can result in unnaturally large time differences *for the room acoustics*. Thus a system with loudspeakers close together, which relies on *the way they radiate* rather than on relative intensity, will do the best job.

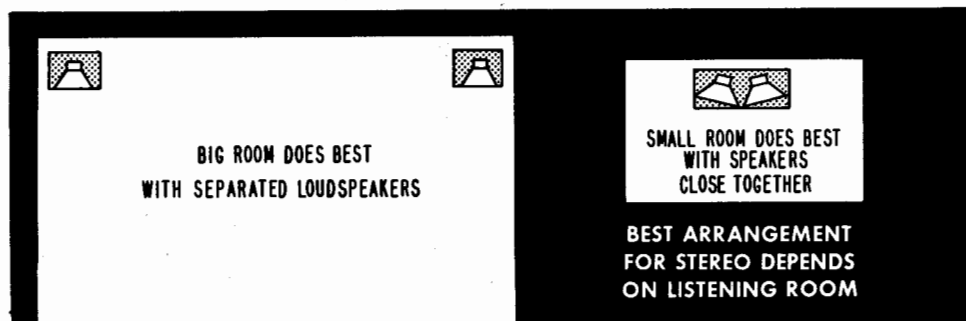

AUDIO AND HEARING

Stereophonic Source Material

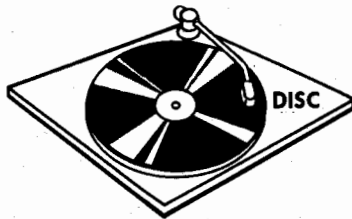

DIFFERENT SOURCES FOR STEREO PROGRAM

To get the most from a home form of entertainment such as stereo, we need a variety of sources. The first — because it was the easiest to adapt — was the two-channel tape recorder. An early attempt to apply it to discs used two separate grooves, spaced apart by a fixed distance. But this was very clumsy to use. What was needed was a means of putting two channels into one groove. This is not basically difficult, but it has practical difficulties that are not really audio problems.

The first idea was to use up-and-down motion of the stylus for one channel and the regular sideways motion for the other. As both are mutually at right angles, neither should affect the other, and they can carry essentially independent programs. With this method, the quality of the two channels was not equal. To overcome this, two motions mutually at right angles are used, but each is at 45° to either vertical or horizontal. This enables equal quality to be used in both channels. By phasing the channels so that unison between them results in the vertical components canceling and the horizontal components adding, the new 45/45 records are compatible with the unsteriophonic LP's—that only carry sideways-motion grooves.

For radio there are several possibilities: an AM broadcasting station can carry one with the FM station carrying the other; two FM stations in the same area can work together to send out half each of the same program. Various other combinations between TV and either AM or FM have been used. But the most promising for general use is one of several multiplexing methods (two channels on a single FM channel) that an adapter can “decode” at the receiver.

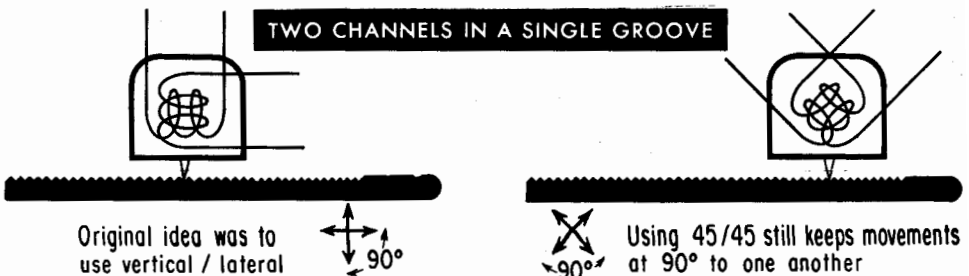

QUESTIONS AND PROBLEMS

1. What kinds of storage medium can be used for audio recording? Name some uses for recording other than high fidelity.
2. What two basic ways are there of recording on discs? How does the problem of making a cutter and pickup for disc recording compare with that of making a loudspeaker and microphone?
3. What kinds of transducer element can be used for a phonograph pickup? Indicate which ones use velocity and which the amplitude principle.
4. Even though velocity recording is the basic form, why do modern recordings deviate so as to approximate nearer to constant amplitude? What turnover frequencies are used for this transition?
5. What is the best way to demagnetize tape or wire completely, preparatory to recording on it, and why?
6. Explain how ultrasonic bias works to improve the quality of magnetic recording.
7. Discuss the basis for equalizer requirements in magnetic recording.
8. How does optical recording work?
9. What is acoustic feedback? Besides the well-known case of a loudspeaker feeding back to a microphone in a public address system, where else can this phenomenon cause trouble?
10. Explain why a loudspeaker needs electrical damping from the amplifier that drives it. What limitations are there to this method of damping? Describe an experiment that demonstrates this.
11. Explain why a recording made with a high quality microphone placed in a typical audience seat would be very disappointing. What ideology of recording or high fidelity does this fact disprove?
12. Explain the physiology of hearing on which this difference between direct hearing and attempts to reproduce the original depends.
13. What is binaural reproduction? How should it be listened to, and what happens if such a recording is played over a more conventional system?
14. Research into the stereophonic nature of sound reveals what important facts? How can the best illusion of realism be achieved?

CUMULATIVE INDEX

NOTE: The first number of each entry identifies the volume in which the information is to be found; the second number identifies the page.

- Absolute standard, 1-105
- Absorption, 1-29
- A-C, 2-16 - 19
 - load resistance, 2-42
 - resistance, 2-8
 - voltages, 2-16
- Accordion, sound of, 1-7
- A-C/D-C supply, 3-61
- Acoustic,
 - amplifiers, 1-44
 - damping, 3-97
 - feedback, 3-94
 - lens, 1-81
 - power, 1-12, 60
 - slit, 1-80
 - vibration, 3-94
- Air, barometric pressure of, 1-5
 - compression of, 1-2, 70
 - density of, 1-5
 - elasticity of, 1-5
 - expansion in, 1-7
 - gap, 1-100
 - modulated pressure in, 1-45
 - movement, 1-2, 23, 50, 67, 73, 106
 - rarefaction in, 1-7, 24
 - sound in, 1-6
 - temperature of, 1-5
- Aircraft equipment, 3-40
- Amplification, current, 2-33
 - factor, 2-8
 - voltage, 2-5, 33
- Amplifier,
 - acoustic, 1-44
 - calibrated, 1-109
 - efficiency, 2-83
 - electric, 1-45
 - electronic, 1-45
 - grounded-cathode, 2-26
 - grounded-grid, 2-27
 - pneumatic, 1-45
 - specifications, 2-114
- Amplifier to loudspeaker coupling, 3-95
- Amplitude of vibration, 1-19
- Amplitude transducers, 3-87
- Analysis of sound, 3-99
- Analyzer, wave, 2-107
- Anechoic room, 1-43
- Asymmetrical waveforms, 3-76
- Audibility, range of, 1-13
- Audio measurements, 1-106
- Audio transformers, 2-96 - 104
- Automatic bias, 3-52
 - volume control, 3-33
- Automobile equipment, 3-40
 - sounds, 3-99
- Back emf, 2-97
- Background, 1-43
- Baffle, bass reflex, 1-70
 - infinite, 1-69
 - loudspeaker, 1-68
 - phase in, 1-71
- Balance in phase splitters, 2-97
- Bandwidth, frequency, 2-51
- Barometric pressure of air, 1-5
- Barrier layer rectifier, 3-41
- Base, 2-32
 - grounded, 2-34
 - time, 2-57
- Bass control, 3-35
- Battery supplies, 3-40
- Beam power tetrode, 2-75
- Bells, sound from, 1-21
- Bias, automatic, 3-52
 - cathode, 3-53
 - grid, 2-6, 3-51
 - push-pull, 3-54
 - screen, 3-56
 - self, 3-52
- Bidirectional microphone, 1-56
- Boost, low- and high-frequency, 3-36
- Bounce, 3-76
- Brick, sound in, 1-6
- Buildup of sound, 1-28
- Bypass capacitor, 3-53
- Calibration of microphones, 1-12
- Cancellation of distortion, 2-77
- Capacitance, coupling, 3-16
 - distributed, 2-62
 - line, 3-72
 - stray, 3-16
 - winding, 2-101
- Capacitor,
 - bypass, 3-53
 - coupling (*see* Coupling capacitor)
 - electrolytic, 3-45
 - in crossovers, 1-94 - 100
 - input filter, 3-45
 - pickups, 3-86
 - smoothing, 3-44
- Carbon microphone, 1-55
- Cardioid microphone, 1-57
- Cathode, 2-2
 - bypass, 3-53
 - follower, 2-31, 3-25
 - grounded, 2-26
- Centering spider, 1-49
- Ceramic pickups, 3-86
- Choke,
 - output, 2-69
 - input filter, 3-47
 - smoothing, 3-43
 - swinging, 3-48
- Circuit,
 - optimum values, 2-66
- Class of operation,
 - A, 2-78
 - AB, 2-81
 - B, 2-79
- Clipping,
 - grid, 2-56, 116
- Closed pipe, 1-22
- Coaxial lines, 3-71
- Cochlea, 3-99
- Coil (*see* Inductor and Voice coil)
- Collector, 2-32
 - grounded, 2-36
- Combined feedback, 3-26
- oscillator, 3-81
- Compressibility of air, 1-5
- Compression of air, 1-2, 70
- Compressor, 3-33
- Computers, 1-1, 3-84
- Concentration, 3-99
- Condenser microphone, 1-51
- Conductance, 2-4
 - mutual, 2-3
- Conductivity in E-M shielding, 3-68
- Cone, loudspeaker, 1-65
- Connections,
 - high impedance, 3-72
 - line impedance, 3-74
 - low impedance, 3-73
 - microphone, 3-71
 - shielded, 3-71
 - twisted cable, 3-72

CUMULATIVE INDEX

- Constant screen potential, 3-58
- Control, automatic volume, 3-33
 - bass, 3-35
 - gain, 3-31
 - industrial process, 3-84
 - supersonic flight, 3-84
 - tone, 3-35
 - tickle, 3-35
 - volume, 3-31
- Copper oxide, 3-41
- Core losses in transformer, 2-101
- Coupling,
 - capacitance, 3-16
 - capacitors, 2-39
 - direct, 2-45
 - inductive, 2-69
 - loudspeaker to amplifier, 3-95
 - necessity for, 2-37
 - size, 2-38
- Crossover,
 - distortion, 3-54
 - parallel-fed, 1-97
 - series-fed, 1-98
 - three-element, 1-101
 - two-element, 1-99
- Crosstalk induction, 3-64
- Crystal,
 - loudspeaker, 1-84
 - microphone, 1-53
 - pickups, 3-86
- Current
 - amplification, 2-33
 - current-dividing network, 1-96
 - feedback, 3-6
 - grid, 2-56
 - magnetizing, 2-97
 - plate, 2-3
 - ratio, 2-96
 - step-up, 2-103
- Curvature of tube
 - characteristics, 2-55
- Cutter,
 - phonograph, 1-105
 - recording, 3-86
- Damping,
 - acoustic, 3-97
 - electrical, 3-95
 - factor, 3-96
- D'Arsonval meter, 2-17
- Data recording, 3-84
- Decay of sound, 1-31
- Decibel, 1-15
- Decibels and gain ratio, 3-5
- Decoupling, 3-49
- Deficiencies in response, 3-35
- Delay voltage, 3-34
- Density of air, 1-5
- Diaphragm,
 - loading of, 1-69
 - loudspeaker, 1-65, 83
 - microphone, 1-47, 51, 54, 55
 - overshoot, 3-95
- Differences, time and intensity, 3-102
- Diode, 2-1
- Direct coupling, 2-45
- Directional listening, 3-98
- Directivity,
 - horn, 1-79
 - microphone, 1-56
- Direct sound, 3-98
- Disc pickups, 3-86
- Dissipation,
 - tube, 2-67
- Distortion, 2-48, 55, 83
 - cancellation, 2-77
 - crossover, 3-54
 - feedback reduces, 3-1
 - harmonic, 2-105
 - intermodulation, 2-108
 - magnetic, 3-90
 - meter, 2-107
 - oscillator with low, 3-81
 - overload, 3-31
 - saturation, 2-98
 - transient, 2-118, 3-75
- Distributed capacitance, 2-62
- Divider, variable voltage, 3-57
- Dividing networks, 1-96
 - current, 1-93
 - voltage, 1-94
- Drive stage, 2-82
 - transformer, 2-104
- Drums, sound of, 1-21, 104
- Dummy head, 3-101
- Dynamic microphone, 1-48
- Dynamic range, 3-31
 - reduction of, 3-33
- Ear,
 - human, 3-99
 - response curves of, 1-110
 - trumpet, 1-44
- Echo, 1-26
- Effective Impedance,
 - input, 3-11
 - output, 3-7
- Effective resistance, 2-44
- Efficiency,
 - amplifier, 2-83
 - loudspeaker, 1-72
- Elasticity of air, 1-5
- Electrical damping, 3-95
- Electrical pickup, 1-19
- Electric induction, 3-65
 - shielding, 3-70
- Electro-acoustics, 3-94
- Electrolytic capacitors, 3-45
- Electron flow, 2-1
- Electronic amplifier, 1-45
- Electronic musical instruments, 3-79, 82
- Electrostatic,
 - induction, 3-70
 - loudspeaker, 1-82
 - microphone, 1-51
- Elimination of hum, 3-60
- Elliptical trace, 2-86
- Emission, cathode, 2-2
 - secondary, 2-14
- Emitter, 2-32
 - grounded, 2-35
- Enclosures, loudspeaker, 1-68 - 79
- Envelope tube, 2-1
 - waveforms, 2-119
- Equalizer, 3-35, 88
- Equipment, test, 3-79
- Erase, ultrasonic, 3-90
- Expansion of air, 1-7
 - of wave, 1-32, 17
- Exponential horn, 1-75
- Extra smoothing, 3-49
- Fechner's Law, 1-15
- Feedback, 3-4
 - acoustic, 3-94
 - changes input impedance, 3-11
 - changes output impedance, 3-7
 - combined, 3-26
 - combined, oscillator, 3-81
 - current, 3-6
 - factor, 3-4
 - fraction, 3-4
 - induction, 3-64
 - negative and positive, 3-3, 26
 - positive, oscillator, 3-80
 - reduces distortion, 3-1

CUMULATIVE INDEX

- series injection, 3-11
- shunt injection, 3-12
- unintentional, 3-50, 64
- voltage, 3-6
- Filament, 2-1
- Filament supplies, 3-59
- Film recording, 3-92
- Filter, capacitor input, 3-45
 - choke input, 3-47
- Floating paraphase, 2-92
- Flight control, 3-84
- Fluorescent screen, 2-57
- Flutter, 3-93
- Folded horn, 1-77
- Fraction fed back, 3-4
- Frequency,
 - bandwidth, 2-51
 - fundamental, 1-18, 3-99
 - harmonic, 1-18
 - logarithmic scale, 1-9
 - low and high, 1-40
 - instruments, 1-37
 - range of musical wave-length and, 1-39, 66
 - response, 2-112
 - shielding effective at, 3-69
- Full-wave rectifier, 3-42

- Gain calculation, 2-11
 - dynamic, 2-5
- Gain control, 3-31
 - infinite, 3-28
 - loop, 3-4
 - margin, 3-19
 - ratio and decibels, 3-5
 - variable, tubes, 3-32
- Generator, tube as, 2-8
- Germanium, 2-32, 3-44
- Gradient, pressure, 1-50, 56
- Grid, 2-2
 - bias, 2-6, 3-51
 - clipping, 2-56, 116
 - current, 2-56
 - grounded, 2-27
 - screen, 2-13
 - suppressor, 2-14
 - voltage, 2-3
- Ground problems, 3-62
- Grounded, base, 2-34
 - cathode, 2-26
 - collector, 2-36
 - emitter, 2-35
 - grid, 2-32
- Guitar, sound of, 1-19

- Half-wave rectifier, 3-42
- Harmonica, sound of, 1-7

- Harmonics, 1-18
- Harmonic, content of waves, 3-82
 - distortion, 2-105
- Hazard, shock, 3-62
- Head, dummy, 3-101
- Headphones, 1-1
- Hearing, threshold of, 1-13
- Heater, 2-2
 - parallel, 3-59
 - series chain, 3-59
- High fidelity, 1-34, 3-84
- High-frequency radiation, 1-40
- High-frequency response, 2-65
- High impedance connections, 3-72
- Horn,
 - directivity, 1-79
 - exponential, 1-75
 - folded, 1-77
 - loudspeaker, 1-72
 - mouth size, 1-75
 - re-entrant, 1-78
 - shapes, 1-74
 - throat, 1-74
 - tractrix, 1-79
- Hum, 3-49
 - elimination, 3-60
- Human ear, 3-99
- Hysteresis, magnetic, 3-90

- Ideal transformer, 2-96
- Impact, 1-4, 42
- Impedance,
 - effective input, 3-11
 - effective output, 3-7
 - effect on induction, 3-66
 - feedback changes input, 3-11
 - feedback changes output, 3-7
 - high, 3-72
 - increase, 3-9, 11
 - line, 3-74
 - low, 3-73
 - microphone, 1-61
 - motional, 3-96
 - ratio, 1-92, 2-96
 - reduction, 3-7, 12
- Importance of transients, 3-103
- Induction, 3-64
 - effective on impedance, 3-66
 - electric, 3-65
 - electrostatic, 3-70
 - magnetic, 3-65
- Inductive coupling, 2-69
- Inductor (in crossovers), 1-95 - 100
- Industrial process control, 3-84
- Infinite baffle, 1-69
- Infinite gain, 3-28
- Input, 2-26
 - transformer, 2-28, 53, 102
- Input impedance, effective, 3-11
- Instability, 3-50, 64, 94
- Instruments, electronic
 - musical, 3-78, 82
- Intensity, 1-11
 - differences, 3-102
- Intercommunication sets, 1-59
- Intermodulation distortion, 2-108
- Internal resistance, 2-8
- Interstage transformers, 2-103
- Inverse-square law, 1-32
- Ionophone, 1-85
- Iron, sound in, 1-6

- Junction transistor, 2-32
 - temperature, 2-52

- Knee of pentode curve, 2-73

- Lateral recording, 3-85
- L-C oscillator, 3-79
- Leakage inductance, 2-101
- Lens, acoustic, 1-81
- Level difference, minimum perceptible, 1-15
- Light valve, 3-92
- Limiting factors (power), 2-67
- Linearity, 2-55
- Line capacitance, 3-72
 - coaxial, 3-71
 - impedance, 3-74
 - matching, 3-74
- Listening, directional, 3-98
 - room, 3-35
 - selective, 3-98
- Load, a-c resistance, 2-42
 - line, 2-21
 - matching, 2-70
 - optimum, 2-71

CUMULATIVE INDEX

- resistor, plate, 2-5, 7
- split, circuit, 2-88
- variation, effect of, 2-71, 83
- Loading diaphragm, 1-69
- Logarithmic,
 - frequency scale, 1-9
 - loudness scale, 1-15
 - volume control, 1-17
- Long-tail phase splitter, 2-94
- Loop gain, 3-4
- Loudness, 1-11
 - scale of, 1-15
- Loudspeaker, 3-35
 - baffle, 1-68 - 79
 - cone, 1-65
 - coupling to amplifier, 3-95
 - crossovers, 1-93
 - crystal, 1-84
 - diaphragm, 1-65, 83
 - efficiency, 1-72
 - electrostatic, 1-82
 - enclosure, 1-68 - 79
 - folded-horn, 1-77
 - horn, 1-72 - 79
 - infinite, 1-69
 - matching, 1-88
 - moving-coil, 1-65
 - moving-iron, 1-64
 - need for, 1-63
 - phasing, 1-71, 102
 - radiation, 1-38
 - response curves, 1-108
- Low distortion oscillator, 3-81
- Low-frequency radiation, 1-40
- Low-frequency response, 2-63
- Low-impedance connections, 3-73
- Magnetic distortion, 3-90
 - hysteresis, 3-90
 - induction, 3-65
 - pickups, 3-86
 - recording, 3-89
 - shielding, 3-67
- Magnetic neutralizing, 2-73
- Magnetic saturation, 2-98
- Magnetic structure, 1-48, 64, 65
- Magnification factor, 2-8
- Magnetizing current, 2-97
- Margin gain, 3-19
 - stability, 3-19, 34
- Marimba, sound of, 1-103
- Matching,
 - line, 3-74
 - load, 2-70
 - loudspeaker, 1-88
 - microphone, 1-60
 - need for, 1-87
 - transformer, 1-60, 89
- Measurements,
 - audio, 1-105
 - dynamic gain, 2-5
 - vibration, 1-1, 3-84
- Megaphone, 1-33, 44, 71
- Meter, D'Arsonval, 2-17
 - distortion, 2-107
 - moving coil, 2-17
 - rectifier, 2-17
- Microphone, 3-35
 - bidirectional, 1-56
 - calibrating, 1-107
 - carbon, 1-55
 - cardioid, 1-57
 - condenser, 1-51
 - connections, 3-71
 - crystal, 1-53
 - diaphragm, 1-47, 51, 54, 55
 - directivity, 1-56
 - dynamic, 1-48
 - electrostatic, 1-51
 - matching, 1-60
 - moving-coil, 1-48
 - need for, 1-47
 - omnidirectional, 1-56
 - piezoelectric, 1-53
 - pressure, 1-56
 - pressure gradient, 1-50
 - response curve, 1-108
 - ribbon, 1-50, 56 - 60
 - sensitivity, 1-58
 - unidirectional, 1-57
 - velocity, 1-50
- Modulated air pressure, 1-45
- Motional impedance, 3-96
- Movement of air, 1-2, 23, 50, 67, 73, 106
- Moving-coil loudspeaker, 1-65
- Moving-coil meter, 2-17
- Moving-coil microphone, 1-48
- Moving-iron loudspeaker, 1-64
- Musical instruments,
 - electronic, 3-78, 82
 - frequency range of, 1-37
- Mutual conductance, 2-3
- Negative feedback, 3-3, 26 (*see also* Feedback)
- Nerve receptors, 3-99
- Neutralizing current, 2-73
- Noise, 1-7, 36; 2-48
 - in tubes and transistors, 2-52
 - resistance, 2-50
 - sources of, 2-50
- Nonlinearity, 2-55
- Nyquist diagram, 3-18
- Octave, 1-9
- Ohm's law, 2-4
- Omnidirectional microphone, 1-56
- Open pipe, 1-24
- Organ, sound of, 1-21, 39
- Oscillation, 3-17, 64
- Oscillator, combined feedback, 3-81
 - L-C, 3-79
 - low distortion, 3-81
 - phase shift, 3-80
 - positive feedback, 3-80
 - waveforms, 3-82
- Oscilloscope, 2-16, 57
 - sweep voltage, 3-82
- Output choke, 2-69
 - transformer, 2-69, 102
- Output impedance, effective, 3-7
- Overshoot, diaphragm, 3-95
- Overtones, 1-18, 3-99
- Parallel-fed networks, 1-96, 97
- Parallel heaters, 3-59
- Paraphase, 2-90
- Particle velocity, 1-3, 23, 58, 70
- Peaking, 3-10
- Peak voltage, 2-16
- Pentode, 2-13, 66, 74
 - knee in curve, 2-76
 - triode-connected, 2-76
- Perceptible level difference, 1-15
- Periodic vibrations, 1-7
- Permeability of magnetic, shielding, 3-67
- Phase, 1-71, 102
- Phase difference, 3-15
- shift oscillator, 3-80
- Phase splitter, balance in, 2-87

CUMULATIVE INDEX

- floating paraphase, 2-92
- long tail, 2-94
- paraphase, 2-90
- split-load, 2-88
- transformer, 2-87
- Piano, sound of 1-7, 3-77
- Pickup, 3-35, 86
 - electrical, 1-19
 - microphone, 1-56
 - phonograph, 1-103
- Piezoelectric loudspeaker, 1-84
 - microphone, 1-53
- Pipe, closed, 1-22
- open, 1-24
- Pipes, sound of, 1-21, 103
- Pitch, 1-8
- Plate, 2-1
 - current, 2-3
 - load resistor, 2-5, 7
 - load variation, 2-71, 83
 - maximum dissipation, 2-67
 - maximum voltage, 2-67
 - resistance, 2-8, 23
 - voltage, 2-3
- Pneumatic amplifier, 1-45
- Polarizing carbon, microphone, 1-55
 - condenser microphone, 1-52
- Port, 1-71
- Positive feedback, 3-3, 26
 - oscillator, 3-80
- Potentiometer feed, 3-56
- Power,
 - acoustical, 1-12, 60
 - capacity of transformer, 2-99
 - drive, 2-82
 - from microphones, 1-60
 - to loudspeakers, 1-89
 - limiting factors, 2-67
- Power induction, 3-64
 - supplies, 3-40
- Pressure barometric, 1-5
 - microphone, 1-50, 56
 - sound, 1-23, 58, 70
- Pressure-gradient, microphone, 1-50, 56
 - sound, 1-23, 58, 70
- Primary inductance, 2-98
- Process control, 3-84
- Propagation velocity, sound, 1-3
- Public address, 3-94
- Push-pull,
 - bias, 3-54
 - operation, 2-73
- Quality of sound, 1-18
- Radiation loudspeaker, 1-38
 - low- and high-frequency, 1-40
- Radio, 1-1
- Range,
 - dynamic, 2-48, 102
 - frequency, 2-51
 - of audibility, 1-13
- Rarefaction of air, 1-7 - 24
- Ratio,
 - impedance, 1-92
 - signal-to-noise, 2-102
 - transformer, 2-96
 - turns, 1-90
- Ratio and decibels, 3-5
- Rayleigh disk, 1-106
- Reactance, capacitive, 2-60
- Receiver, radio, 1-1
 - telephone, 1-58
- Receptors, nerve, 3-99
- Recognition of sound patterns, 3-99
- Recorders, 3-35
- Recording, 1-1
- Recording cutters, 3-86
 - data, 3-84
 - disc, 3-85
 - lateral, 3-85
 - magnetic, 3-89
 - studio, 3-35
 - variable area, 3-99
 - variable density, 3-92
 - vertical, 3-85
- Rectification, 2-1, 3-41
- Rectifier meters, 2-17
- Rectifier types, 3-42
- Reducing distortion, 3-1
 - dynamic range, 3-18
 - impedance, 3-7, 12
- Reeds, sound of, 1-21, 103
- Re-entrant horn, 1-78
- Reference point, 2-26
- Reflected sound, 1-27, 3-98
- Reflex enclosure, 1-70
- Reinforcement by reverberation, 1-36
- Reproduction, audio, 1-1
 - binaural, 3-101
 - stereophonic, 3-102
- Resistance, 2-4
 - a-c, 2-8
 - acoustic, 3-79
 - capacitance coupling, 2-39
 - effective, 2-44
 - internal, 2-8
 - load, 2-42
 - noise, 2-50
 - plate, 2-8, 23
 - source, 3-96
- Resistor, grid, 2-38
 - load, 2-5, 7
 - series feed, 3-56
- Resonance, 1-103, 3-35
- Response curve, human ear, 1-110
 - loudspeaker, 1-108
 - microphone, 1-108
- Response deficiencies, 3-35
 - square-wave, 3-75
 - tape, 3-91
 - transient, 3-75, 95
- Response, frequency, 2-112
 - high-frequency, 2-65
 - low-frequency, 2-63
 - square-wave, 2-118
- Reverberation, 1-41
 - reinforcement by, 1-36
 - time, 1-31
- Ribbon microphone, 1-50, 56, 60
- Ringings, 3-75
- Ripple, 3-42
 - tank, 1-28
- Rms (root mean square), meaning of, 2-19
- Rumble, 3-93
- Saturation, magnetic, 2-98
- Sawtooth wave, 2-57, 3-82
- Screen bias, 3-56
 - constant potential, 3-58
- Screen, fluorescent, 2-57
 - grid, 2-13
- Secondary emission, 2-14
- Secondary standard, 1-107
- Self bias, 3-52
- Selective listening, 3-98
- Selenium, 3-41
- Sensitivity, microphone, 1-58
- Series-fed networks, 1-94, 98
- Series heaters, 3-59
 - injection (feedback) 3-11
 - resistor feed, 3-56
- Shadow effects, 1-40
- Shielded line, 3-71

CUMULATIVE INDEX

- Shielding, 3-64
 conductivity of E-M, 3-68
 electric, 3-70
 electromagnetic, 3-68
 frequency effective at, 3-69
 magnetic, 3-67
 permeability, 3-67
- Shock hazard, 3-62
- Shock wave, 1-2
- Shunt injection (feedback), 3-12
- Signal-to-noise ratio, 2-102
- Silicon, 2-32, 3-41
- Sine wave, 2-16, 3-82
- Sinusoidal waveform, 2-16
- Slit, acoustic, 1-80
- Smoothing, 3-42
 capacitor, 3-44
 choke, 3-43
 extra, 3-49
- Sonar, 1-1
- Soundboard of piano, 1-7
- Sound,
 analysis, 3-99
 automobile, 3-99
 build-up of, 1-31
 decay of, 1-31
 direct, 3-98
 direction of, 1-38
 effect of wind on, 1-35
 field, 1-105
 in various materials, 1-6
 of bars, 1-21
 of bells, 1-21
 of musical instruments, 1-7, 19, 21, 23, 38, 103
 pattern recognition, 3-99
 pressure, 1-23, 58, 70
 quality, 1-18
 reflected, 3-98
 reflection of, 1-28
 speech, 1-42
 speed of, 1-3
 violin, 3-99
 waves, 1-3
- Sources of noise, 2-50
- Sources of power, 3-40
- Source resistance, 3-96
- Speaking tube, 1-72
- Specifications, amplifier, 2-114
- Speech sounds, 1-42
- Speed of sound, 1-3
- Spider, centering, 1-49
- Split-load circuit, 2-88
- Square-wave generator, 3-82
 response, 2-118, 3-75
- Stability margin, 3-19, 34
- Standard, absolute, 1-105
 secondary, 1-107
- Standing waves, 1-24, 28, 105
- Steel, sound in, 1-6
- Step-up, current or voltage, 2-103
- Stereophonic reproduction, 3-102
- Stray capacitance, 3-16
- Supersonic flight, 1-2
 control, 3-84
- Super tweeter, 1-93
- Supplies, battery, 3-40
 filament, 3-59
- Supply, a-c/d-c, 3-61
 transformerless, 3-61
- Suppressor grid, 2-14
- Suspension, 1-49
- Sweep voltage for oscilloscope, 3-82
- Swinging choke, 3-48
- Tape recorders, 3-35
 response, 3-91
- Telephone, 1-55, 58, 104
- Temperature, effect on
 noise of, 2-52
- Test equipment, 3-79
- Tetrode, beam power, 2-75
- Thermionic rectifier, 3-41
- Three-element crossover, 1-101
- Timbre, 1-18, 103
- Time and intensity differences, 3-102
- Time base, 2-57
- Time constants, 2-39
- Time, reverberation, 1-31
- Tone, continuous, 1-30
 interval, 1-9
- Tractrix horn, 1-79
- Transconductance, 2-3
 variable, 3-32
- Transducer, 1-47
 amplitude and velocity, 3-87
- Transformer, audio, 2-96 - 104
 core losses, 2-101
 drive, 2-104
 ideal, 2-96
 input, 2-28, 53, 102
 interstage, 2-103
 matching, 1-60, 89
 output, 2-69, 102
 phase splitter, 2-87
 power capacity, 2-99
- Transformerless supply, 3-61
- Transient distortion, 2-118, 3-75
 effects, 3-77
 importance of, 3-94, 103
 response, 3-75, 95
- Transients, 1-41
- Transistors, 2-32
 noise in, 2-52
- Transmitter, radio, 1-1
 telephone, 1-55, 58, 104
- Treble control, 3-35
- Triangle, sound of, 1-21
- Triode, 2-1
 pentode connected as, 2-76
 twin, 2-11
 types, 2-12
- Trumpet, ear, 1-44
 sound of, 1-38
- Tube, 2-1
 as generator, 2-8
 characteristics, 2-11, 55
 dissipation, 2-67
 noise in, 2-52
 variable gain, 3-32
- Turns ratio, 1-90
- Turntable, 3-93
- Tweeters, 1-67, 93
- Twin triode, 2-11
- Twisted cable connections, 3-72
- Two-element crossover, 1-99
- Ultrasonic, 3-90
- Unidirectional microphone, 1-57
- Unintentional feedback, 3-50, 64
- Variable area recording, 3-92
 density recording, 3-92
 gain tubes, 3-32
 transconductance, 3-32
 voltage divider, 3-37
- Vector representation, 3-15
- Velocity microphone, 1-50
- Velocity particle, 1-3, 23, 58, 70
 propagation, 1-3
- Velocity transducers, 3-87

CUMULATIVE INDEX

- Vertical recording, 3-85
- Vibration, acoustic, 3-94
 - amplitude of, 1-19
 - measurement, 1-1, 3-84
 - periodic, 1-7
- Violin, sound of, 1-7, 3-99
- Voice coil, 1-49, 65, 69
- Voice personality, 3-99
- Voltage a-c, 2-103
 - amplification, 2-5, 33
 - average, 2-18
 - grid, 2-3
 - maximum plate, 2-67
 - peak, 2-16
 - plate, 2-3
 - rms, 2-19
 - step-up, 2-103
- Voltage delay, 3-34
 - divider, 3-57
 - feedback, 3-6
 - variable divider, 3-37
- Voltmeters, 2-17
- Volume control, 1-17, 3-31
 - automatic, 3-33
 - limiter, 3-34
- Water, sound in, 1-6
- Wave, analyzer, 2-107
 - expansion, 1-32, 74
 - harmonic content of, 3-82
 - sawtooth, 2-57, 3-82
 - sine, 2-16, 3-82
 - sound, 1-3
 - square, 2-118, 3-82
 - standing, 1-3
- Waveforms, asymmetrical,
 - envelope, 2-119
 - oscillator, 3-82
- Wavelength and frequency,
 - 1-39, 66
- Winding capacitance, 2-101
- Wind instruments,
 - sound of, 1-7
- Wow, 3-93
- Xylophone, sound of, 1-103

